

**TECHNICAL
INFORMATION**

In the interest of continuing product improvement,
we reserve the right to change models,
specifications, and/or features without prejudice.

PROJECT: _____
 LOCATION: _____
 ARCHITECT: _____
 ENGINEER: _____
 CONTRACTOR: _____
 DATE: _____ SALES ENGINEER: _____

15000-TT, 13' Model Shown
Available 4", 5", 6" or 8"
Standard

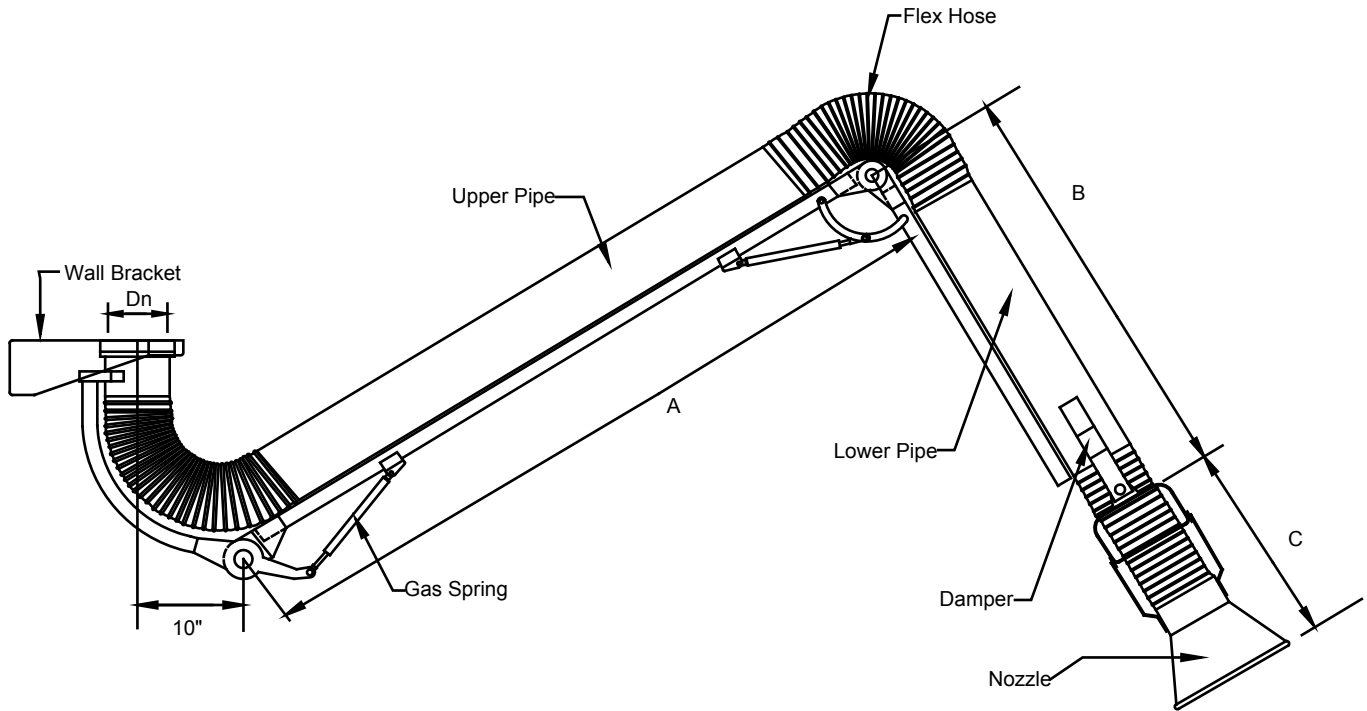

Model	A	B	C	Dn	Description	Weights (lbs.)
15134-TT	75.1"	41.3"	20.2"	4"	13' x 4" Tube Type Arm	70
15135-TT	75.1"	41.3"	20.6"	5"	13' x 5" Tube Type Arm	75
15136-TT	75.1"	41.3"	21.0"	6"	13' x 6" Tube Type Arm	80
15138-TT	75.1"	41.3"	21.4"	8"	13' x 8" Tube Type Arm	85

*Optional hood mounted light kit available, consult factory for pricing

*Stainless Steel option available, consult factory for pricing

Contact factory for bench-top mount, other configurations