

**TECHNICAL
INFORMATION**

In the interest of continuing product improvement,
we reserve the right to change models,
specifications, and/or features without prejudice.

PROJECT: _____
 LOCATION: _____
 ARCHITECT: _____
 ENGINEER: _____
 CONTRACTOR: _____
 DATE: _____ SALES ENGINEER: _____

Series - 3011
Exploded View

Side View

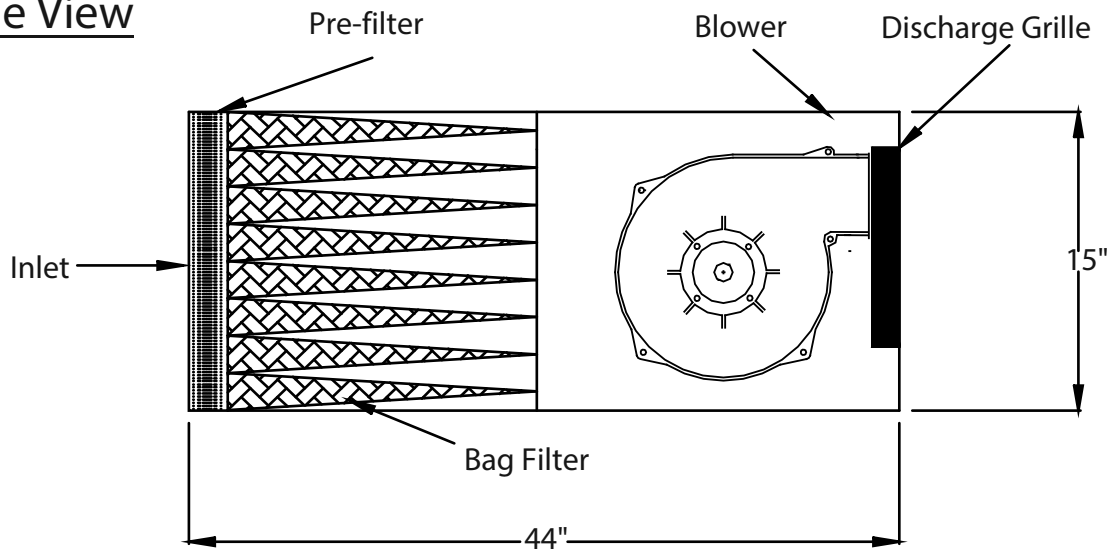

End View

