

Macurco™ DVP-120

Detection and Ventilation Control Panel

Operation Instructions



IMPORTANT: Keep these user instructions for reference.

Table of Contents

1	General Safety Information.....	5
1.1	List of warnings.....	5
2	Use Instructions and Limitations.....	6
2.1	DVP-120 General Description	6
2.2	Features.....	7
2.3	Specifications.....	7
3	Installation Instructions	8
3.1	Location & Mounting.....	8
3.2	Mounting.....	8
3.3	Installation.....	9
3.3.1	General Wiring Information	9
3.3.2	Power Connection.....	10
3.3.3	Remote Sensor Connection	11
3.3.4	Relay Connection	12
3.3.5	Horn & Strobe Connection.....	13
3.3.6	Interfacing Macurco Sensors	13
4	Operation.....	14
4.1	Power up	14
4.1.1	Status Light Display	14
4.2	User Interface.....	15
4.2.1	Cursor Keys	15
4.2.2	MENU Key	15
4.2.3	Hush Key	16
4.3	Normal Status Display.....	16
4.4	ALARM Status Display.....	16
4.5	Warning Status Display.....	17
4.6	Trouble Status Display	18
4.7	Ventilation Control	18
4.7.1	Zone Signal Display	19
4.8	System Configuration	19
4.8.1	System Menu	20
4.8.2	Configure System Submenu.....	20
4.8.3	Configure Sensors Submenu	26
4.8.4	Configure Relays, Horn & Strobe Submenu	27

- 4.8.5 Configure Horn Submenu 29
- 4.8.6 Configure Strobe Submenu 29
- 4.8.7 Configure Zones Submenu 30
- 4.8.8 Configure Signals Submenu 34
- 5 Troubleshooting 38
 - 5.1 System Status Light 38
 - 5.1.1 Input Channel Trouble 38
 - 5.1.2 Internal Controller board Trouble 39
 - 5.2 Timed ventilation problem 39
 - 5.3 No Power 39
 - 5.4 LCD Display Unreadable 39
 - 5.5 Keypad does not respond 40
 - 5.5.1 After silencing Alarm, Warning or Trouble 40
 - 5.6 Power Failure 40
- 6 Testing & Maintenance 41
 - 6.1 Testing 41
 - 6.1.1 Keypad Test 41
 - 6.1.2 Functionality Test 41
 - 6.2 Maintenance 41
- 7 Appendix A – Table of Figures 42
- 8 Appendix B – Quick Setup 44
 - 8.1 Configure System Submenu 47
 - 8.1.1 Set Time of Day 47
 - 8.1.2 Set Day of Week 47
 - 8.1.3 Load Default Configuration 47
 - 8.1.4 Change Password 47
 - 8.1.5 Enter Password 48
 - 8.2 Configure Sensors Submenu 48
 - 8.2.1 See section 4.2 Initial Operating Mode for more detail 48
 - 8.2.2 See section 4.3 User Interface for more detail 48
 - 8.2.3 See section 4.13 System Configuration for more detail 48
 - 8.2.4 See section 4.13.3 Configure Sensors Submenu for more detail 48
 - 8.3 Configure Relays, Horn & Strobe Submenu 49
 - 8.3.1 See section 4.13.4 Configure Relays, Horn & Strobe Submenu for more detail 49
 - 8.4 Configure Zones Submenu 50

Macurco DVP-120 Operation Manual

8.4.1 See section 4.13.7 Configure Zones Submenu for more detail..... 50

8.5 Configure Signals Submenu 52

8.5.1 See section 4.13.8 Configure Signals Submenu for more detail 52

9 Appendix C – Setup Record..... 53

10 Appendix D – DVP-120 Quick Start Guide 54

11 Macurco Gas Detection Product limited warranty 55

Technical Support Contact Information 55

General Contact Information 55



1 General Safety Information

1.1 List of warnings

 WARNING
Each person using this equipment must read and understand the information in this User manual before use. Use of this equipment by untrained or unqualified persons or use that is not in accordance with this user manual, may adversely affect product performance.
This equipment helps monitor for the presence and concentration level of certain specified airborne gases. Misuse may produce an inaccurate reading, which means that higher levels of the gas being monitored may be present and could result in overexposure. For proper use, see supervisor or User manual, or call Macurco Technical Service at 1-844-325-3050.
DVP-120 may not function effectively below 32°F (0°C) or above 120°F (49°C). Using the equipment outside of this temperature range may adversely affect product.
High voltage terminals (120/240 VAC) are located within the DVP-120, presenting a hazard to service technicians. Only qualified technicians should open the DVP-120 case and service the internal circuits. Ensure power is removed from the DVP-120 prior to servicing the unit.
Immediately exit any environment that causes an alarm condition on the sensor.
Each time the unit is turned on it performs a self-test, which activates the audible and visual alarms. If the self-test fails, or all the alarms do not activate, do not use and contact Technical Support at 1-844-325-3050.
Do not cover or obstruct audible alarm opening or visual alarm LED. Doing so may adversely affect product performance.
Do not disassemble unit or attempt to repair or modify any component of this instrument. This instrument contains no user serviceable parts, and substitution of components may adversely affect product performance and void product warranty.
Use only for monitoring the gases which the sensors and equipment are designed to detect. Failure to do so may result in exposures to gases not detectable and result in serious injury or death. For proper use, see supervisor or User manual, or Contact Technical Support at 1-844-325-3050.
Failure to follow instructions outlined in this user manual can result in sickness or death.

2 Use Instructions and Limitations

2.1 DVP-120 General Description

The DVP-120 exhaust fan controller, in conjunction with Macurco™ gas detector, controller, transducers, provides automatic controls to help maintain an acceptable environment in parking garages or other facilities. The DVP-120 system is designed to meet specifications for safety in enclosed parking garages, including the Uniform Building Code and OSHA 50ppm CO requirements. The standard DVP-120 can control up to twelve gas sensors in any combination (i.e. CO, NO₂, EX, etc.). The DVP-120 is ready for operation after the wiring is complete and the user system configuration is entered.

WARNING

Each person using this equipment must read and understand the information in this User manual before use. Use of this equipment by untrained or unqualified persons or use that is not in accordance with this user manual, may adversely affect product performance.

2.2 Features

- Externally visible LCD display showing the status of each transducer and relay
- External keypad for user selection of the transducer/alarm display and setting the configuration (password protected)
- Up to three ventilation control zones can be defined
- Each zone can be controlled based on transducer signals and/or time of day
- Each relay is configurable for delay before activation and minimum on time
- Fail safe operation can be implemented
- Lockable NEMA 1 type enclosure
- Modular input and output connectors
- Twelve analog (current loop) input channels
- Three 10A, 240 VAC SPDT fan/alarm relays
- Drivers for external Horn and Strobe
- ETL Listed to UL 2017¹ (Type SM)

¹Where required by federal, state, local regulations or the Authority Having Jurisdiction, DVP-120 is required to be used with Listed Horn/Strobe model 78-2900-0211-X* to meet the 85dB(A) Audibility requirements of Standards UL 2017.

*Where "X" represents lens cover color, R for red lens cover, G for green lens cover, B for blue lens cover, O for amber lens cover, C for clear lens cover

2.3 Specifications

- Size: 10.5" x 12.5" x 2" (267 mm x 318 mm x 51 mm)
- Weight: 6 ½ lb. (2.9 kg)
- Enclosure: NEMA 1 Type
- Operating Temperature: 32 to 120°F (0° to 49°C)
- Operating Humidity: 0% to 95% RH non-condensing
- Power Input: 90 – 250 VAC, 1 Amp, 47 – 63 Hz, single phase
- Relay Rating (3): SPDT, 120/240 VAC, 10 A resistive
- LCD Display: 2 rows of 16 characters with backlight
- Status Indicators (LED): Power, ALARM/warning, Hush, Relay 1, Relay 2 & Relay 3
- Audible indicator: Internal buzzer, 90 dBA at 1ft
- External Drivers (2): 24VDC, maximum 250 mA
- Carbon Monoxide (CO) Range: 0 – 200ppm
- Nitrogen Dioxide (NO₂) Range: 0 – 20ppm
- Combustible (EX) Range: 0 – 50% LEL
- Ammonia (NH₃) Range: 0 – 100ppm
- Hydrogen Sulfide (H₂S) Range: 0 – 50ppm
- Refrigerant (REF) Range: 0 – 1,000ppm
- Oxygen (O₂) Range: 0 – 25% v/v
- Carbon Dioxide (CO₂) Range: 0 – 5,000ppm
- Wild Card (WC) Range: Variable
- Relay On Delay: 0 – 15 minutes in 1 second increments
- Relay Minimum Run Time: 0 – 15 minutes in 1 second increments

3 Installation Instructions

3.1 Location & Mounting

Gas detection and exhaust fan control is provided by a Macurco™ DVP-120 system. System wiring includes the main power connection for the DVP-120, 4-20mA current loop and 24VDC power connections between the remote sensors and the DVP-120, the fan control connections and/or alarm connections from the DVP-120 to the building ventilation and automation systems.

The system configuration is entered by the user through the LCD display and keypad. The system display provides the user with the system status, and the status of each configured sensor. In addition, all control functions of the DVP-120 may be accessed through the system display and keypad.

WARNING

This equipment helps monitor for the presence and concentration level of certain specified airborne gases. Misuse may produce an inaccurate reading, which means that higher levels of the gas being monitored may be present and could result in overexposure. For proper use, see supervisor or User manual, or call Macurco Technical Service at 1-844-325-3050.

This DVP-120 system should be used with Macurco™ transducers and each unit will measure the level of the target gas (i.e. CO, NO₂, EX, etc.) and provide this information to the DVP-120 over a 4-20mA current loop. The transducers operate on low voltage (24VDC). All power and signal connections for the transducers are provided from the DVP-120 control panel, via unshielded four conductor cable. The DVP-120 control panel provides three relays which can be used for ventilation fan control or alarm signaling. These relays (SPDT - Form C) are for pilot duty only, capable of switching 10 amp loads up to 240 VAC. Main power wiring should conform to national and local electrical codes and may require separate inspections and certification. Contact your local building authority for further details.

WARNING

DVP-120 may not function effectively below 32°F (0°C) or above 120°F (49°C). Using the equipment outside of this temperature range may adversely affect product.

3.2 Mounting

Mounting holes are provided in the DVP-120 case at the four corners. The top two are keyhole shaped so that the panel can be hung and then the two bottom screws driven to hold the panel. See figure 2-1. The panel should be mounted with sufficient space all around for access to Conduit entry holes provided on the top, bottom and right side of the panel.



Figure 3-1 Mounting Holes

Typical coverage for CO, CO₂ and NO₂ sensors is 5,000 sq. ft. (464.5 sq. m), 900 sq. ft. (83.6 sq. m) for combustibles and other toxic gases (see the User Instructions of each sensor type for location and coverage details). Extra sensors may be needed near areas where people work, such as toll booths. Macurco provides only the control panels and sensors. Fans, relays, and other devices are provided by the contractor. See the appropriate building code for the size of fans and air changes per unit of time.

NOTE: For Typical coverage, please see Operation Manual for the Macurco sensor (CM-6, TX-6-ND, CD-6H, GD-6,...)

3.3 Installation

3.3.1 General Wiring Information

⚠ WARNING

High voltage terminals (120/240 VAC) are located within the DVP-120, presenting a hazard to service technicians. Only qualified technicians should open the DVP-120 case and service the internal circuits. Ensure power is removed from the DVP-120 prior to servicing the unit.

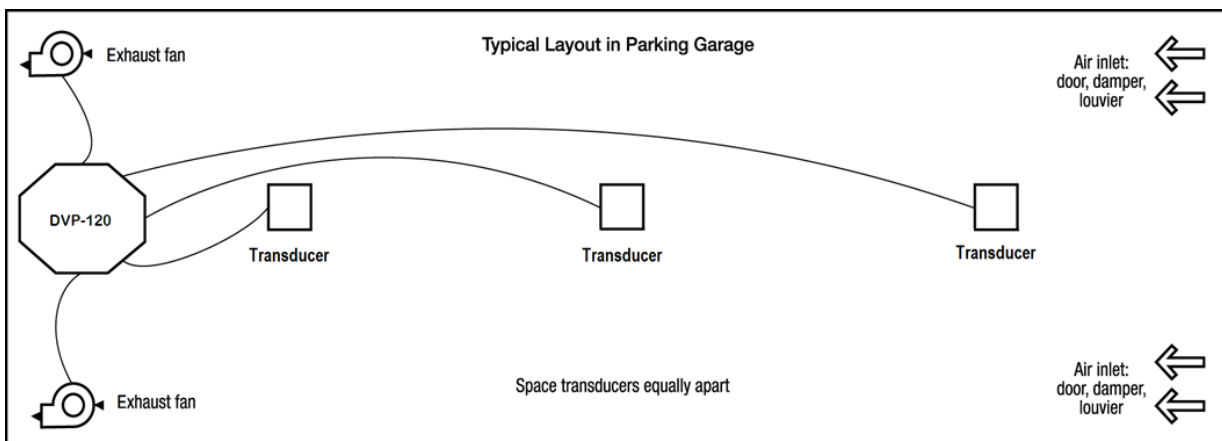

Figure 3-2 Typical Layout

With the exception of the safety ground, all field wiring is completed via modular connectors (provided). After wiring, simply plug the modular connectors into the matching connectors on the printed circuit board (PCB).

Note: It is recommended to always install with wires enclosed within the rigid metallic conduit.

The power and signal connections to the remote mounted sensors should be size AWG18 (minimum) for short runs. Refer to Table 2-2 for recommended wire gauges. Four conductor cables may be used in all cases since the DVP-120 employs DC power for remote sensors to help prevent electrical noise from interfering with the sensor output signal.

Do not bundle sensor power and/or signal connections with other AC power cables to prevent electrical interference. If other AC power connections must be bundled with the DVP-120 sensor cables, the sensor connections should be made with two twisted pairs of the appropriate gauge, with an overall foil and braid shield. All shields should be terminated at the DVP-120 end of the cable only. A ground stud is provided near the bottom left corner of the panel.

3.3.2 Power Connection

The main power cable should be routed into the bottom left conduit entry. Macurco recommends a minimum wire size of AWG18 and the wire insulator must be rated for 140°F (60°C) service. The modular connector will accept wire from 12 to 24 AWG. The safety ground wire should be secured to the ground stud at the bottom left of the cabinet with the lock washer and nut supplied. Use a ring terminal for the ground connection. Refer to Table 2-1 for DVP-120 power connections. The line and neutral wires should be stripped 1/4 in. (6.5 mm), insert the wire into the wire cavity of the modular connector and tighten the screw clamp. Ensure that the wire cannot be easily pulled from the connector. Plug the modular connector into AC~ on the PCB and ensure that it latches into the header properly.

Signal	Connector	Pin Number
Line (120/220/240/250 VAC)	AC~	3
Neutral	AC~	1
Ground	Ground Stud	n/a

Table 3-1 Main Power Connections

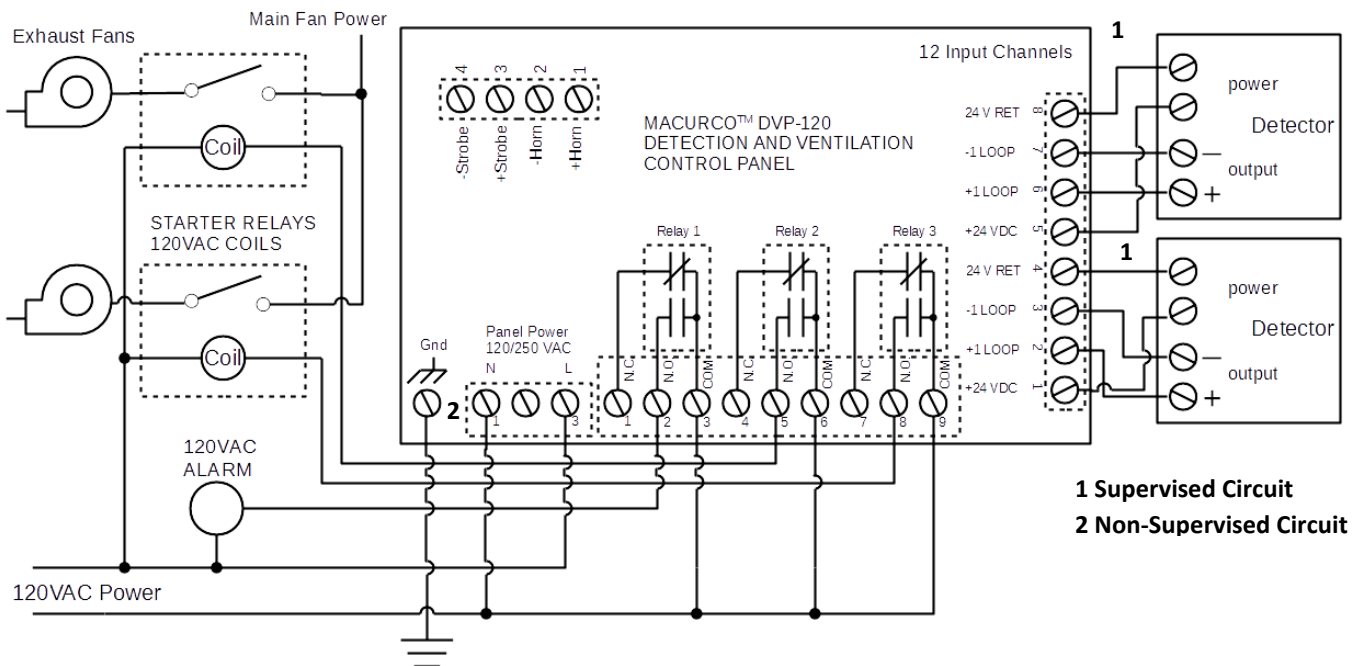

Figure 3-3 System Wiring Diagram

3.3.3 Remote Sensor Connection

Each remote sensor is connected by a four-wire connection – two wires for DC power and two wires for the 4 – 20 mA loop connection. The sensors are connected to the control panel PCB with modular connectors, two sensors per connector. See Figure 2-5 for a view of a typical sensor connector. Refer to Table 2-2 for wire size recommendations.

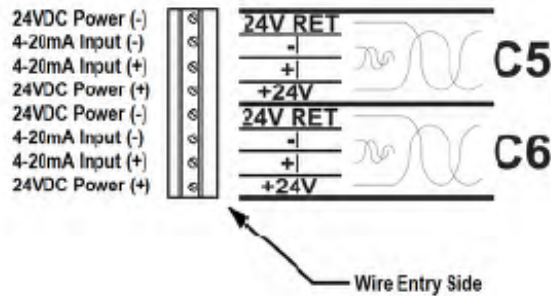

Figure 3-4 Sensor Interface Connection – Channels 5 and 6

Note: If CX-6 (CO and NO₂ dual sensor) is connected to Channel X in DVP-120 then address X is assigned to NO₂ sensor and address “X+12” is assigned to CO Sensor.

Each 8-terminal sensor modular connector may be disconnected from the PCB connector to ease wire installation. The terminals will accept wire from 16 to 28 AWG. To install a wire, strip back approximately 0.25 in. (6 mm) of insulation and insert the bare wire into the terminal. Tighten the screw clamp and ensure that the wire cannot be easily pulled from the connector. Connector to sensor C1 through C12 correspondence to all 12 input channels.

Wire Gauge	Maximum Run Length	
	(feet)	(meters)
18	500	152
16	800	244
14	1250	381

Table 3-2 Recommended Wire Gauge

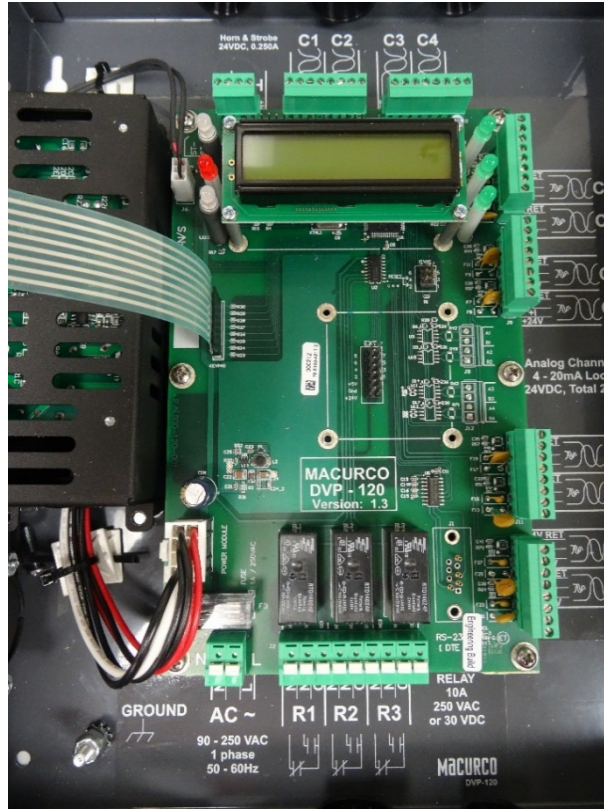

Figure 3-5 DVP-120 Internal View

3.3.4 Relay Connection

All poles of the three relays are available at the modular connector R1 R2 R3 (see Figure 2- for details). R1 R2 R3 is a 9-position variant of the high voltage modular connector used for power input. Each terminal can accommodate a wire size 12 to 24 AWG.

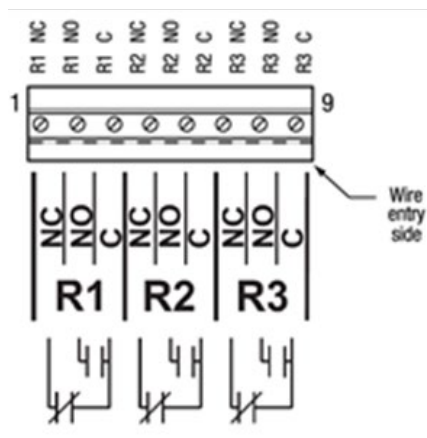

Figure 3-6 Relay Connections

To install the wiring for the relays, disconnect the connector from the header on the PCB. Strip the insulation of each wire back approximately 1/4 in. (6.5 mm), insert the bare wire into the terminal and tighten the screw clamp. Ensure that the wire cannot easily be pulled from the connector.

3.3.5 Horn & Strobe Connection

The external horn and strobe connections are available at the modular connector S H (see Figure 2- for details). S H as a 4-position connector, similar to the sensor interface connectors.

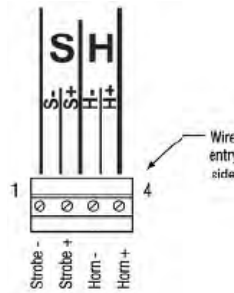

Figure 3-7 Horn & Strobe Connector

To install the wiring for the horn or strobe, disconnect the connector from the header on the PCB. Strip the insulation of each wire back approximately 0.25 in. (6 mm), insert the bare wire into the terminal and tighten the screw clamp. Ensure that the wire cannot easily be pulled from the connector. When all wires are connected, seat the modular connector into the PCB header; ensure that the latch engages. Refer to Table 2-3 for recommended wire gauge vs. run length for the horn & strobe functions (maximum 2.5 volt drop in the wire). The Strobe and Horn circuits are Class 2 control circuits so Class 2 conductors should be used.

Wire Gauge	Maximum Run Length	
	(feet)	(meters)
24	200	61
22	340	103
20	480	147
18	850	215

Table 3-3 Wire Gauge for Horn & Strobe Functions

⚠ WARNING

Immediately exit any environment that causes an alarm condition on the sensor.

3.3.6 Interfacing Macurco Sensors

Macurco sensors with current loop outputs may be used with the DVP-120. See macurco.com for information on compatible Macurco gas transducers. See specific information on other manufacturer’s transducers.

Power connections to Macurco sensors used with the DVP-120 are polarity-insensitive (no polarity), since a bridge rectifier is connected to the power input terminals. All sensors used with the DVP-120 panel employ screw clamp terminal blocks for power and signal connections. Polarity of the current loop connections is marked on the modular connector of the sensor.

NOTE: After complete system installation, verify all sensors (verify sensor address and sensor type) connected to the panel are detected by the panel and there is not any trouble indication for any of the connected detector. Refer to Section 4.8.3 to scroll through all sensors detected by the panel.

4 Operation

4.1 Power up

When power is first applied to the DVP-120, a few simple self-tests will be performed, and the system will cycle through all status lights, and display the system name and model # (Figure 3-1). The system will then proceed to normal mode, if the operating parameters have been entered.



DVP - 120 Ver 3.00.D

Figure 4-1 Model Display

WARNING

Each time the unit is turned on it performs a self-test, which activates the audible and visual alarms. If the self-test fails, or all the alarms do not activate, do not use and contact Technical Support at 1-844-325-3050.

If the user has not entered any parameters, the system WILL NOT be controlling the ventilation system. The relays WILL NOT actuate, and the horn and strobe outputs WILL NOT be powered. The power status light will show NORMAL (steady green) and the system will immediately enter the CONFIGURATION mode, see section 3.2 for details to set the configuration parameters.

If a valid set of configuration parameters have been entered, the panel will wait for all sensors to warm up. During this time, the display will show a count-down, minutes and seconds, until the end of the warm-up period, (Figure 3-2).

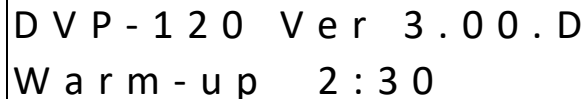

DVP - 120 Ver 3.00.D
Warm-up 2:30

Figure 4-2 Warm-Up display

During the warm-up period, the keypad will be locked. When the warm-up period ends, the LCD will start showing the normal display.

4.1.1 Status Light Display

The POWER, ALARM/WARNING, SILENCE, RELAY 1, RELAY 2 and RELAY 3 status lights indicate the system status and provide the following data:

- POWER
 - Green (steady) – Power is good and there are no trouble indications
 - Yellow (steady) – Trouble is indicated by a transducer or the panel itself
- ALARM/WARNING
 - Off – All indicated gas levels are below the warning level
 - Red (steady) – One or more gas levels is at or above the alarm level
 - Amber (steady) – One or more gas levels is at or above the warning level
- HUSH
 - Off – There are no silenced alarms or warnings
 - Red (flashing) – There are alarms, warnings and/or troubles that have been silenced (gas levels may or may not remain or continue to be at alarm or warning levels)

- RELAY 1
 - Off – Relay 1 is not on
 - Green (steady) – Relay 1 is on
- RELAY 2
 - Off – Relay 2 is not on
 - Green (steady) – Relay 2 is on
- RELAY 3
 - Off – Relay 3 is not on
 - Green (steady) – Relay 3 is on

The overall system status is visible at a distance via the status lights as described above. More detailed system information is displayed on the LCD, which can show the status of each relay and sensor. A typical status display is shown in Figure 3-4.

4.2 User Interface

The LCD display is used to show detailed information about the status of the control system and the configuration parameters to the user. The keypad is used to select the information displayed and to enter the configuration parameters, which are stored in the DVP-120 memory. The keypad consists of the usual ten-digit keys, four direction keys, plus a MENU key that is used to access the configuration menu and a HUSH key that will silence the audible alarm indicators. In normal mode, holding the zero key for three (3) seconds can be used to lock the keypad against accidental (or unauthorized) use. See Section 4.5 for details.



Figure 4-3 Keypad layout

4.2.1 Cursor Keys

In normal mode, (no warnings or alarms indicated), the up and down cursor keys will scroll the display to any configured sensors' status. In normal mode, the left and right cursor keys will scroll through the status of each of the relays. When the left (or right) key is used to scroll to another relay, the display will remove the underlining under the sensor number and underline the relay number; this indicates that the digit keys can be used to jump directly to a particular relay's status. When the up or down key is again used the display will switch back to the digit keys jumping to a particular sensor.

4.2.2 MENU Key

The MENU key has three functions. First, when the system is presenting the normal display, pressing the MENU key will cause the system to shift to the Configuration Menu. The second function of the MENU key is to return to the next-higher menu level, e.g. from the sensor configuration menu to the system menu, or from the system menu out to normal mode. If in the middle of entering a multi-digit parameter, the MENU key also cancels any changes to the parameter. When the MENU key is used to return to normal mode, any changed configuration parameters are saved in the DVP-120's memory. The third function of the MENU key is to change the LCD contrast by holding the MENU key for five (5) seconds, at which point the LCD will prompt for further activities, see sections 4.4 for more detail.

4.2.3 Hush Key

The HUSH key is only used to silence the audible indicators (internal buzzer and possible external Horn and Strobe devices). Pressing and releasing the button will silence the internal buzzer. The HUSH button must be held for 3 seconds to silence the Horn and Strobe devices.

4.3 Normal Status Display

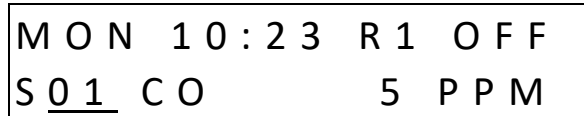

Figure 4-4 Normal System Display

The display shows the day of the week and the time of day, in 24-hour format. It also shows the status of one of the relays, R1 in this example, and the type and indicated gas concentration of one of the configured sensors, S01 is a CO sensor indicating 5ppm in this example.

Notice in Figure 3-4 that the digits 0 1 are underlined; this indicates that the digit keys can be used to jump directly to another sensor’s status. When the first digit is pressed, the display will prompt for the second digit of the target sensor.



Figure 4-5 Sensor prompt

In this example, the first digit entered was 1. Since the DVP-120 can handle 12 sensors, the first digit for a sensor number is either 0 or 1. The leading zero must be entered when selecting a sensor less than ten. When the second digit is entered, the normal display will be restored; showing the type and value for the selected sensor.

As mentioned above, the left and right scroll keys will display the next or previous relay’s status. The display will also change the underline to indicate that the digit keys (zero, one and two) can be used to jump directly to a particular relay. Since only one digit is needed to select a relay, the system does it immediately rather than prompting to show the relay.

If the sensor is indicating a gas level that is greater than the alarm or warning levels, the gas reading will alternate with the words ALARM or WARNING as appropriate. If a sensor fails, a connection is lost or the panel itself detects a failure of its own, the panel will enter TROUBLE mode and the gas reading will be replaced by the word TROUBLE (the TROUBLE status condition is discussed in section 3.1.6 below).

4.4 ALARM Status Display

When any sensor indicates a gas level that is at or above the configured alarm level for the sensor, the panel will enter ALARM mode, during which the internal buzzer will sound, the alarm lamp will be red and the LCD will show the sensor type and channel number.



Figure 4-6 Alarm display

The display will cycle through all sensors that are signaling alarm levels, at five seconds per display. Pressing any key (except HUSH) will advance the display to the next sensor that is signaling an alarm level.

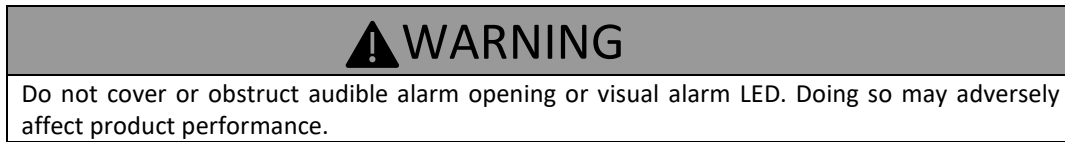

If an external horn and/or strobe are connected and configured to signal an alarm condition, they will also sound when an alarm condition occurs, after a delay if that configuration option is used.

When the HUSH key is pressed, the internal buzzer will be silenced for five (5) minutes. If the horn or strobe turn on delays have not finished, then they will also be silenced. If the delays have finished the HUSH key must be held for three (3) seconds in order to silence the horn and strobe.

When all indicators have been silenced, the display will show that alarms have been silenced for five minutes. After any key is pressed (or five seconds), the display will return to normal mode.



Figure 4-7 Alarm Silenced message

If Relay 1 is configured as an ALARM relay, it will be turned on when an alarm condition is recognized and will be turned off when all audio indicators have been silenced using the HUSH key.

4.5 Warning Status Display

When any sensor indicates a gas level that is at or above the configured warning level for the sensor, the panel will enter WARNING mode during which the internal buzzer will sound, the alarm/warning lamp will be amber and the LCD will show the sensor type and channel number.



Figure 4-8 Warning display

The display will cycle through all sensors that are signaling warning levels, at five seconds per display. Pressing any key (except HUSH) will advance the display to the next sensor that is signaling a warning level.

If the buzzer and/or an external horn and/or external strobe are connected and configured to signal a warning condition, they will also sound when a warning condition occurs. There is a configurable delay before the horn or strobe will sound, see sections 4.8.5.1 and 4.8.6.1.

When the HUSH key is pressed, the internal buzzer will be silenced for fifteen (15) minutes. If the horn or strobe turn on delays have not finished, then they will also be silenced. If the delays have finished, the HUSH key must be held for three (3) seconds in order to silence the horn and strobe.

When all indicators have been silenced, the display will show that warnings have been silenced for fifteen minutes. After any key is pressed (or five seconds) the display will return to normal mode.



WARNING SILENCED
FOR 15 MINUTES

Figure 4-9 Warning Silenced message

4.6 Trouble Status Display

If a sensor fails, a connection is lost or the panel itself detects a failure of its own, the panel will enter TROUBLE mode during which the internal buzzer will sound, the power lamp will be yellow and the LCD will display the specific sensor identified.

Possible trouble conditions are:

- Any configured channel has less than 4 mA flowing in the current loop
- A sensor is reporting a trouble condition
- Any configured channel wiring is open.
- Internal controller board problems are detected.



Trouble
CO Sensor 02

Figure 4-10 Trouble display

The display will cycle through all trouble indications, at five seconds per display. Pressing any key (except HUSH) will advance the display to the next trouble indicator.

If an external horn and/or strobe are connected and configured to signal a trouble condition, they will also sound when a trouble condition occurs, after a delay, if that configuration option is selected.

When the HUSH key is pressed, the internal buzzer will be silenced for eight (8) hours. If the horn or strobe turn on delays have not finished, then they will also be silenced. If the delays have finished, the HUSH key must be held for three (3) seconds in order to silence the horn and strobe.

When all indicators have been silenced, the display will show that trouble indications have been silenced for eight hours. After any key is pressed (or five seconds), the display will return to normal mode.



TROUBLE SILENCED
FOR 8 HOURS

Figure 4-11 Trouble Silenced message

4.7 Ventilation Control

The ventilation control function operates independently from the alarm function. It provides the ability to configure the DVP-120 for control of one to three zones. Each zone can respond to gas levels indicated by one or more of the sensors, with configurable turn on and turn off concentrations (rising and falling) for each gas type. Each zone can also be controlled based on the time of day.

Each zone can be configured to control one, two or all three of the relays and the external horn and strobe if desired. When more than one zone is controlling a relay it only takes one zone to activate the relay, but all controlling zones must release the relay before it will turn off.

Each of the relays, horn and strobe has independent turn on delays (to ignore short duration, transient gas signals) and turn off delays (to ensure minimum run times for fans that must run for internal cooling).

4.7.1 Zone Signal Display

When a zone is controlling the horn or strobe and they are activated, the panel will enter ZONE SIGNAL mode during which the horn and/or strobe will be turned on and the LCD will show the zone that is signaling.



Z O N E S I G N A L
Z O N E 1

Figure 4-12 Zone Signal display

The display will cycle through all zones that are controlling the horn or strobe and are signaling, at five seconds per display. Pressing any key (except HUSH) will advance the display to the next zone that is signaling.

When the HUSH key is held for three (3) seconds, the horn and/or strobe will be silenced for fifteen (15) minutes. When silenced, the display will show that zone signals have been silenced for fifteen minutes. After any key is pressed (or five seconds) the display will return to normal mode.



Z O N E S I L E N C E D
F O R 1 5 M I N U T E S

Figure 4-13 Zone Signal Silenced message

4.8 System Configuration

The configuration menus can be entered from normal mode by pressing the MENU key. While in configuration mode, the user can review all configuration parameters to check the current operating conditions. As an aid when configuring the control panel, the first entry in the top menu summarizes the number of sensors and relays that the panel is currently recognizing. Be sure that the 4-20mA output on each sensor is set to "On".



5 S E N S O R S F O U N D
3 R E L A Y S F O U N D

Figure 4-14 Hardware Summary

The MENU key is also used to return to a higher-level menu and finally exit the configuration menus back to normal mode. When exiting from the menu system to normal mode, if any configuration changes have been made, the panel will ask whether changes are to be saved.

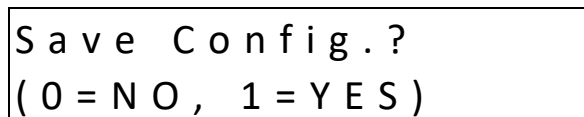

S a v e C o n f i g . ?
(0 = N O , 1 = Y E S)

Figure 4-15 Save Configuration Prompt

Pressing the zero (0) key at this point will cancel all changes except time and day of week. Pressing the one (1) will save all changes to memory, and the changes will then become effective in controlling the ventilation system.

While the DVP-120 is in the configuration mode, alarm and ventilation control functions continue in the background with the previously set configuration values. In particular, if an alarm condition is detected, the alarm lamp, the buzzer, the horn and the strobe will operate as configured but the LCD will not display the detailed information. The HUSH key can be used to silence any alarm, warning or trouble indicators without having to exit the configuration mode. If the MENU key is used to exit the configuration mode before using the HUSH key, the LCD will display the cause of the audible indicator.

The numeric keys are used to change the particular parameter displayed. The underlined character, or space, on each display indicates what will be changed by the digit keys.

The left and right cursor keys will enter the particular submenu and scroll through the items of the same type where appropriate, e.g. enter the Configure Sensors submenu and scroll through the parameter lists for the existing sensors.

The up cursor key scrolls through the menu entries in the order listed here, while the down cursor key scrolls in the reverse order. Changing the configuration parameters requires the entry of a password before changes can be made. The default password is 1234. See Figure 3-21 for an example of the password prompt.

In many cases the parameter is entered as a string of digits, but some parameters are selected by pressing a single key, e.g. pressing 1 selects Monday, 2 selects Tuesday, etc.

4.8.1 System Menu

The top menu level allows the user to select:

- Configure System
- Configure Sensors
- Configure Relays, Horn & Strobe
- Configure Zones
- Configure Signals

The up and down cursor keys can be used to scroll through the entries in the list, while the left or right key will enter the particular submenu.

The MENU key will return to normal mode. If any configuration parameters have been changed, the panel will prompt to save the changes. If the changes are saved, this is the point at which they become effective in controlling the ventilation system and for alarm level detection. Note that changes to the time and day of week are not considered configuration items; they are saved as soon as they are entered.

4.8.2 Configure System Submenu

The system configuration submenu provides entries to:

- Set the time of day, 24-hour format
- Set the day of the week, day 1 is Monday
- Load Default Configuration
- Change Password
- Configure Sensor Type

4.8.2.1 Set Time of Day

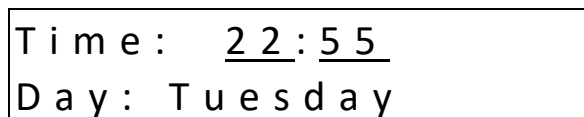

The image shows a rectangular LCD display with a black border. The text is displayed in a monospaced font. The first line reads "Time: 22:55" where the "22" and "55" are underlined. The second line reads "Day: Tuesday".

Figure 4-16 Set Time of Day

This display example shows that the time is 22:55 (10:55 PM). The underlined characters indicate that the numeric keys can be used to set the current time of day. When the first digit is entered (and after the password is entered if required), the display will change to show that the “hour” portion of the time is currently being entered.

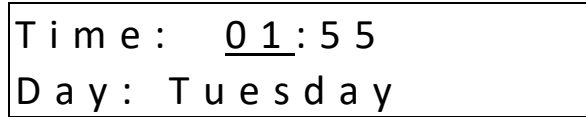

Figure 4-17 Enter Hours

In this example, the first digit entered was 1 (one), and the panel is waiting for the second digit of the hour to be entered. If the second digit is not entered within five seconds, the time will revert to the previous value. After the second digit of the hour is entered, the display will prompt for the “minute” entry:

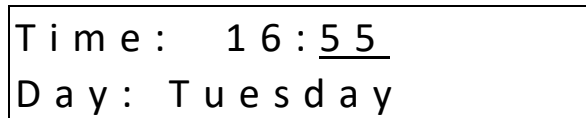

Figure 4-18 Enter Minutes

In this example, the hour (16) has been accepted and the panel is waiting for the minute to be entered. If no digits are entered within 5 seconds, the entry will be finished without changing the minute; however, the hour will be changed to the value entered.

Note that the time is saved as soon as the fourth digit is entered.

4.8.2.2 Set Day of Week

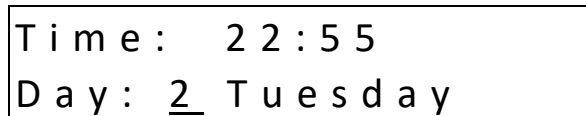

Figure 4-19 Set Day of the week

This display example shows that Tuesday is the current day of the week. The underline character indicates that the day can be changed by entering the corresponding digit:

- 1 - Monday
- 2 - Tuesday
- 3 - Wednesday
- 4 - Thursday
- 5 - Friday
- 6 - Saturday
- 7 - Sunday

Note that the day of the week is saved as soon as the digit is entered.

4.8.2.3 Load Default Configuration

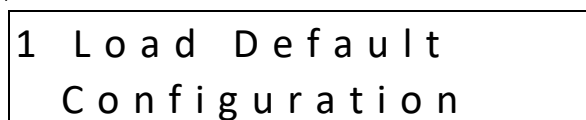

Figure 4-20 Load Default Configuration

When the number one (1) digit is pressed, the panel will prompt for the password, even if it has been entered previously. If the password is entered correctly, the panel will overwrite the existing configuration with the default configuration. This operation is intended to restore the panel to a known basic condition if it is removed from one installation and installed in another.

The Default Configuration is:

- Password 1234
- Sensors Undefined
- Alarm signals Buzzer = Intermittent, Horn = Intermittent, Strobe = Continuous
- Warning signals Buzzer = Off, Horn = Off, Strobe = Off
- Trouble signals Buzzer = Triple Tap, Horn = Off, Strobe = Off
- Relay 1 Normally off, 1-minute turn on delay, 1 minute minimum on time
- Relay 2 Normally off, 1-minute turn on delay, 1 minute minimum on time
- Relay 3 Normally off, 1-minute turn on delay, 1 minute minimum on time
- Horn Normally off, 1-minute turn on delay, 0 (zero) minimum on time
- Strobe Normally off, 1-minute turn on delay, 0 (zero) minimum on time
- Zone 1 Controls R1
- Zone 2 Controls R2
- Zone 3 Controls R3
- Group 1 in each zone Type 1 CO, Voting mode, Quorum = 1
- Group 2 in each zone Type 2 NO₂, Voting mode, Quorum = 1
- Group 3 in each zone Type 3 EX, Voting mode, Quorum = 1
- Group 4 in each zone Type 4 NH₃, Voting mode, Quorum = 1
- Group 5 in each zone Type 5 H₂S, Voting mode, Quorum = 1
- Group 6 in each zone Type 6 REF, Voting mode, Quorum = 1
- Group 7 in each zone currently unused
- Group 8 in each zone Type 8 O₂, Voting mode, Quorum = 1
- Group 9 in each zone Type 9 CO₂, Voting mode, Quorum = 1

Description	Carbon Monoxide	Nitrogen Dioxide	Combustible Gas	Ammonia	Hydrogen Sulfide	Refrigerants	Carbon Dioxide	Oxygen
Type	CO	NO ₂	EX	NH ₃	H ₂ S	REF	CO ₂	O ₂
Range	200 ppm	20 ppm	50% LEL	100 ppm	50 ppm	1,000 ppm	5,000 ppm	25% v/v
Alarm Level	200 ppm	5 ppm	20% LEL	75 ppm	20 ppm	300 ppm	4,000 ppm	19.5% v/v
Warning Level	100 ppm	3 ppm	15% LEL	50 ppm	14 ppm	200 ppm	1,500 ppm	20.0% v/v
Rising Level	35 ppm	2.5 ppm	10% LEL	25 ppm	8 ppm	100 ppm	1,000 ppm	20.3% v/v
Falling Level	15 ppm	1.2 ppm	5% LEL	10 ppm	3 ppm	50 ppm	800 ppm	20.6% v/v

Table 4-1 Default Type settings

4.8.2.4 Change Password

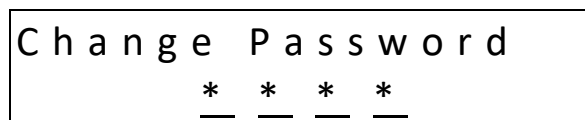

Figure 4-21 Change Password

When the first digit is entered to change the password, the panel will prompt for the existing password to be entered (if it hasn't already been entered), see section 3.3.2.5 for more detail. Once the current password has been entered, the panel will prompt for the new password.

4.8.2.5 *Configure Sensor Type*
Sensor Registration

Sensor registration is continuously monitored by the DVP-120. When the currently selected sensor type agrees with the stored registration information the DVP-120 will remain in normal mode. When new registration information is detected by the DVP-120, for example if a different gas type of Macurco sensor was installed, the following message is displayed: "Configuration Changed Any key to save" is displayed.

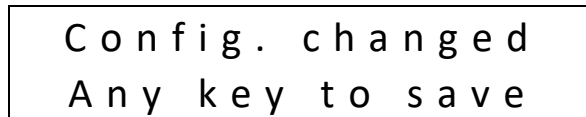

Figure 4-22 Configuration Changed

Pressing any key will prompt user to enter the password. Once the valid password is entered the new sensor type is saved. The program does not allow any other activity unless valid password is entered.

If the DVP-120 is in configuration mode (user is changing the configuration) the registration information is saved in the background and the message indicating that configuration was changed is delayed until user goes back to normal mode.

Custom Sensor Implementation

Custom sensor types or "wildcards" can be configured with the DVP-120. There are 8 Macurco sensor types and 21 custom sensor types available. Though the Macurco sensor data cannot be changed, custom sensor parameters can be configured to define the sensor type:

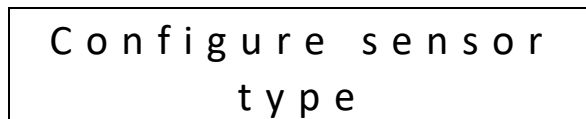

Figure 4-23 Configure Sensor

From this menu you can access any of the following menus to change type parameters using the navigation key up, down, left and right.

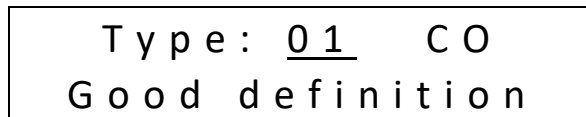

Figure 4-24 Sensor Definition

CO for carbon monoxide is one of the 8 Macurco sensor types already defined.

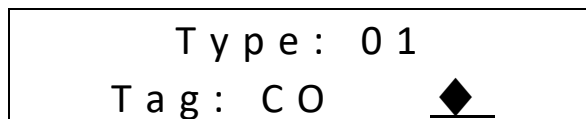

Figure 4-25 Sensor Tag

“Tag” is a 3-character parameter and is used to identify the sensor type (i.e. CO, EX...)

Type: 01 CO
Units: ppm <u>◆</u>

Figure 4-26 Sensor Units

“Units” is a 4-character parameter and indicates the engineering units (i.e. ppm, %LEL...)

Type: 01 CO
Depletion: <u>0</u> No

Figure 4-27 Depletion Type

“Depletion” is “1” when the sensor is a depletion type and “0” when it is not a depletion type sensor. A depletion sensor detects when gas concentrations in a space fall below a specified level.

Type: 01 CO
Dec.: <u>0</u> 8888. ppm

Figure 4-28 Decimal Points

“Dec.” defines how many decimal points are used to display the reading, alarm, warning, range, rising and falling levels. It can have values between 0 and 2.

Type: 01 CO
Res.: <u>1</u> ppm

Figure 4-29 Resolution

“Res.” Defines the resolution used to display the reading, alarm, warning, range, falling level and rising level. It can have values between 1 and 500 when “Dec.” is 0, 50.0 when “Dec.” is 1 and 5.00 when “Dec.” is 2.

Type: 01 CO
Range: <u>200</u> ppm

Figure 4-30 Sensor Range

“Range” is the value displayed when current measured is 20mA.

Type: 01 CO
Alarm: <u>200</u> ppm

Figure 4-31 Alarm Level

“Alarm” is the default alarm range.

Type: 01 CO
Warn: <u>100</u> ppm

Figure 4-32 Warning Level

“Warn” is the default warning range.

Type: 01 CO
Rise: <u>35</u> ppm

Figure 4-33 Rising Trip Point

“Rise” is the default rising level used in Zone configuration.

Type: 01 CO
Fall: <u>15</u> ppm

Figure 4-34 Falling Trip Point

“Fall” is the default falling level used in Zone configuration.

For the custom sensor types default parameters are set to display the current measured above 4 mA. If the current is 4 mA, it displays 0.00 mA. And when the current is 20 mA it displays 16.00 mA.

4.8.2.6 Enter Password

If the password has not yet been entered, when the first digit of any parameter is entered, the panel will prompt for the current password. Note that the first digit entered is discarded; it does not count toward the password or toward the parameter entry.

Enter Password
— — — —

Figure 4-35 Enter Password

When the first digit is entered, the panel will show.

Enter Password
— — — *

Figure 4-36 Password Prompt

If the password is not entered correctly the panel will display

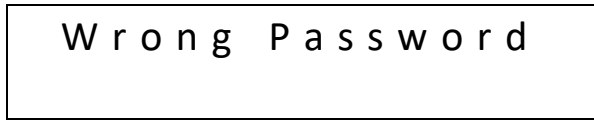

Figure 4-37 Wrong Password Prompt

Once the current password has been entered, the panel will prompt for the configuration parameter being changed.

If the password has been lost:

1. Power down the DVP-120
2. Remove the Jumper Shorting Connector from the EXT header and place the Jumper Shorting Connector onto the top two pins of the SYS header.
3. Power up the DVP-120. The first display is the current password on the unit.
4. Remove the Jumper Shorting Connector from the SYS header and install back onto the two bottom pins of the EXT header.

4.8.3 Configure Sensors Submenu

There is a list of parameters for each sensor in the system, either currently wired or configured but presently disconnected. The left and right cursor keys can be used to move from one sensor to another and the up and down keys will scroll through the parameters for the particular sensor.

4.8.3.1 Sensor Summary

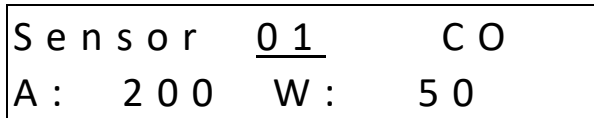

Figure 4-38 Sensor Summary

This display example shows that the sensor on channel 01 has been configured as a Carbon Monoxide sensor with an Alarm level of 200ppm and a Warning level of 50ppm.

Notice that the sensor number, 01 in this example, is underlined. This indicates that the digit keys can be used to jump to a particular channel, even if there is no sensor connected to the channel.

4.8.3.2 Sensor Type

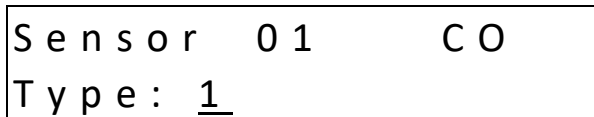

Figure 4-39 Sensor Type

This display example shows that the sensor on channel 01 has been configured as a Carbon Monoxide sensor. The valid entries for Macurco type sensors are Carbon Monoxide (CO), Nitrogen Dioxide (NO₂), Combustible Gas (EX), Ammonia (NH₃), Hydrogen Sulfide (H₂S), Refrigerants (REF), Carbon Dioxide (CO₂) and Oxygen (O₂).

Setting the sensor type to 0 (zero) will cause the display to ask if the user wants to DELETE the sensor. If the answer is yes, the configuration record for this sensor channel will be deleted and the channel will no longer be used to control the ventilation system. When a sensor's type is changed, the alarm level, warning level and range will be set to the default for the sensor type.

The following three parameters are not accessible until a sensor type of 1, 2 or 3 is selected.

4.8.3.3 Alarm Set Point

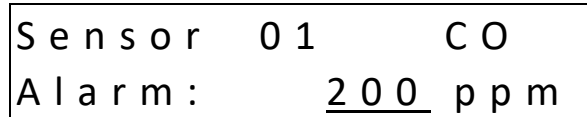

Figure 4-40 Sensor Alarm Level

The default alarm levels for the sensors are:

Description	Carbon Monoxide	Nitrogen Dioxide	Combustible Gas	Ammonia	Hydrogen Sulfide	Refrigerants	Carbon Dioxide	Oxygen
Alarm Level	200 ppm	5 ppm	20% LEL	75 ppm	20 ppm	300 ppm	4000 ppm	19.5% v/v

Setting an alarm level of 0 (zero) will disable alarm detection for this particular sensor.

4.8.3.4 Warning Set Point

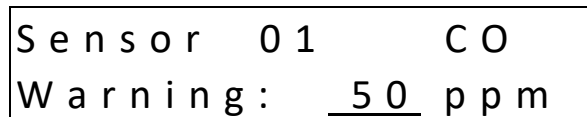

Figure 4-41 Sensor Warning Level

The default warning levels for the sensors are:

Description	Carbon Monoxide	Nitrogen Dioxide	Combustible Gas	Ammonia	Hydrogen Sulfide	Refrigerants	Carbon Dioxide	Oxygen
Warning Level	100 ppm	3 ppm	15% LEL	50 ppm	14 ppm	200 ppm	1500 ppm	20.0% v/v

Setting a warning level of 0 (zero) will disable warning detection for this particular sensor.

4.8.3.5 Range

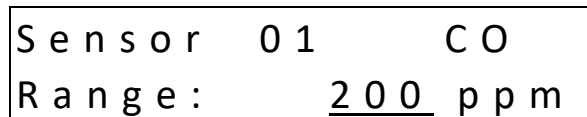

Figure 4-42 Sensor Range

The range for each sensor is the gas concentration that corresponds to the 20-mA signal level.

The default range values for the sensors are:

Description	Carbon Monoxide	Nitrogen Dioxide	Combustible Gas	Ammonia	Hydrogen Sulfide	Refrigerants	Carbon Dioxide	Oxygen
Range	200 ppm	5 ppm	50% LEL	100 ppm	50 ppm	1000 ppm	5000 ppm	25.0% v/v

4.8.4 Configure Relays, Horn & Strobe Submenu

There is a list of parameters for each relay in the system. The left and right cursor keys can be used to move from one relay, horn or strobe to another and the up and down keys will scroll through the parameters for the particular relay, horn or strobe.

4.8.4.1 Relay Summary

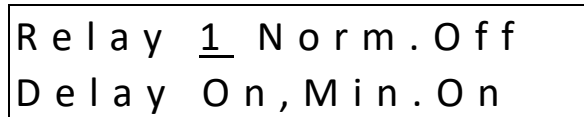

Relay 1 Norm. Off
Delay On, Min. On

Figure 4-43 Relay Summary

This display example shows that Relay 1 is configured to operate Normally Off, with a turn on delay and a minimum on time.

Notice that the relay number, 1 in this example, is underlined. This indicates that the digit keys can be used to jump to a particular relay, horn or strobe. The relays are numbers 1, 2 and 3; the horn is number 4 and the strobe is 5.

4.8.4.2 Relay Mode

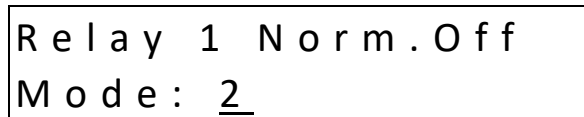

Relay 1 Norm. Off
Mode: 2

Figure 4-44 Relay Mode

This display example shows that relay 1 is configured to operate in the Normally Off mode. The relay modes are:

- 1 - ALARM
- 2 - Normally Off (default)
- 3 - Normally On

Relay mode 1 is a special case. This mode is only available on relay 1 and dedicates the relay to function as an alarm signal to a subsequent alarm or monitoring panel. This mode forces the relay to Normally Off mode with no turn on delay or minimum on time. See Section 3.1.4 for more detail regarding alarms

Fail Safe operation can be implemented by configuring a relay to operate Normally On, and wiring the circuit using the NC (normally closed) contact. In this way, if the control panel loses power the relay will turn on the controlled device if it still has power.

4.8.4.3 Relay Turn on Delay

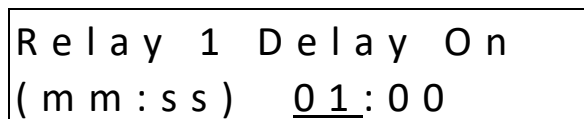

Relay 1 Delay On
(mm:ss) 01:00

Figure 4-45 Turn on Delay

The default turn on delay is one minute and the maximum allowed value is fifteen minutes. The value is entered in two groups, 2 digits for the minutes and then 2 digits for the seconds. A leading zero must be entered for each group if applicable.

4.8.4.4 Relay Minimum on Time

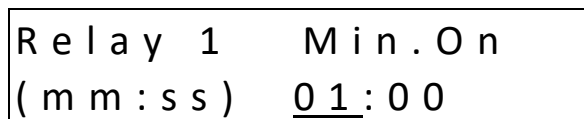

Relay 1 Min. On
(mm:ss) 01:00

Figure 4-46 Minimum on Time

The default minimum on time is one minute and the maximum allowed value is fifteen minutes.

4.8.5 Configure Horn Submenu

The configuration parameters for the horn are similar to those for relays. A horn would not normally require a minimum on time, but this parameter allows a more versatile configuration.

4.8.5.1 Horn Summary

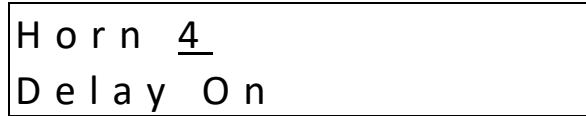

Figure 4-47 Horn Summary

This display example shows that the horn has been configured to operate with a turn on delay and no minimum on time.

Notice that the horn number, 4, is underlined. This indicates that the digit keys can be used to jump to a particular relay, horn or strobe.

The relays are numbers 1, 2 and 3; the horn is number 4 and the strobe is 5. The default turn on delay is one minute and the maximum allowed value is fifteen minutes.

4.8.5.2 Horn Minimum On Time

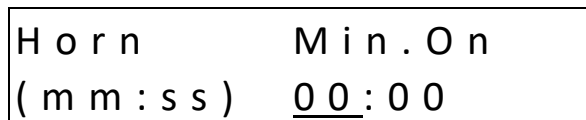

Figure 4-48 Horn Minimum on Time

The default minimum on time is zero and the maximum allowed value is fifteen minutes.

4.8.6 Configure Strobe Submenu

The configuration parameters for the strobe are the same as those for relays. A strobe would not normally require a minimum on time, but this parameter allows a more versatile configuration.

4.8.6.1 Strobe Summary

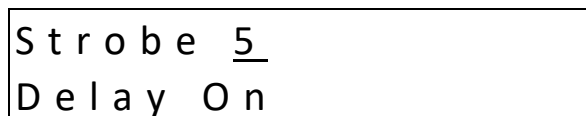

Figure 4-49 Strobe Summary

This display example shows that the strobe has been configured to operate with a turn on delay and no minimum on time.

Notice that the strobe number, 5, is underlined. This indicates that the digit keys can be used to jump to a particular relay, horn or strobe. The relays are numbers 1, 2 and 3; the horn is number 4 and the strobe is 5.

4.8.6.2 Strobe Minimum on Time

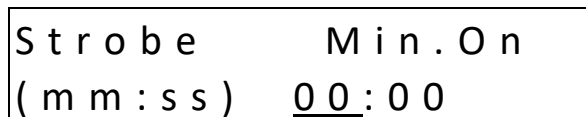

Figure 4-50 Strobe Minimum on Time

The default minimum on time is zero and the maximum allowed value is fifteen minutes.

4.8.7 Configure Zones Submenu

The DVP-120 ventilation control can support up to three zones. The zone functionality makes the DVP-120 very flexible. For example, each zone can be configured to monitor a separate set of four sensors and control a single relay.

Another control scheme uses one zone to monitor all sensors and turn one relay on at a relatively low gas concentration. A second zone monitors the same sensors and turns on a second relay if the gas concentration reaches a higher level. The third zone can also monitor the same relays turning the last relay on as a signaling device to a live monitor station, as well as turning on the external horn and strobe, under the assumption that the ventilation system is not working.

In addition to controlling the relays based on the gas concentration, each zone can have a timed function, e.g. turn on low volume ventilation fans at 7:00 AM and turn them off at 8:00 PM.

The default Ventilation Controls are:

- Zone 1 controls Relay 1
- Zone 2 controls Relay 2
- Zone 3 controls Relay 3

4.8.7.1 Zone Controls

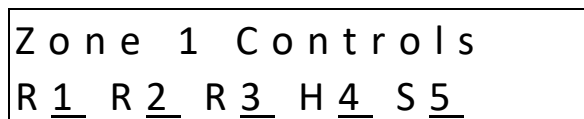

Figure 4-51 Zone Controls

This display example shows that Zone 1 is configured to control all of the relays plus the horn and the strobe. Each of the relays, the horn and the strobe can be removed from (or added to) the zones control by pressing the indicated digit key. By default, Zone 1 will control Relay 1, Zone 2 will control Relay 2 and Zone 3 will control Relay 3.

Definitions:

- Zone – Defines Sensor Input & Relay / Alarm Output
- Group – Set of Sensors of same type and output within the same zone.
- Average – Activation based upon an average of sensors in a group
- Voting – Number of sensors needed to be above trip point to activate output
- Quorum – Number of sensors need to vote, 1 = any sensor.

The digit controls are:

- 1 - Relay 1 added/removed from the zone's control
- 2 - Relay 2 added/removed from the zone's control
- 3 - Relay 3 added/removed from the zone's control
- 4 - Horn added/removed from the zone's control
- 5 - Strobe added/removed from the zone's control

When controlled by a zone the default horn pattern is the Triple Tap pattern, see 3.3.8.7 and the strobe will turn on continuously when a zone is controlling them.

Each zone can have up to three control groups defined. Each group either monitors a sensor type or implements a timer function.

4.8.7.2 Zone Group Type

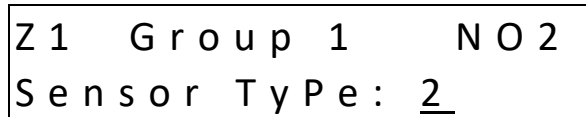

Figure 4-52 Zone Group Type

This display example shows that group 1 in zone 1 will be monitoring Nitrogen Dioxide sensors. The valid Types are:

- 0 - Timed
- 1 - Carbon Monoxide (CO)
- 2 - Nitrogen Dioxide (NO₂)
- 3 - Combustible (EX)
- 4 - Ammonia (NH₃)
- 5 - Hydrogen Sulfide (H₂S)
- 6 - Refrigerants (REF)
- 7 - currently unused
- 8 - Oxygen (O₂)
- 9 - Carbon Dioxide (CO₂)

The default types are:

Group 1 in each zone	Type 1 CO, Voting mode, Quorum = 1
Group 2 in each zone	Type 2 NO ₂ , Voting mode, Quorum = 1
Group 3 in each zone	Type 3 EX, Voting mode, Quorum = 1
Group 4 in each zone	Type 4 NH ₃ , Voting mode, Quorum = 1
Group 5 in each zone	Type 5 H ₂ S, Voting mode, Quorum = 1
Group 6 in each zone	Type 6 REF, Voting mode, Quorum = 1
Group 7 in each zone	currently unused
Group 8 in each zone	Type 8 O ₂ , Voting mode, Quorum = 1
Group 9 in each zone	Type 9 CO ₂ , Coting mode, Quorum = 1

NOTE: If CX-6 is connected to DVP-120, it will occupy two address and appear as one CO (Type: 1) sensor and one NO₂ (Type 2) sensor on the panel.

Timed mode turns the zone’s outputs on at the START TIME if the current day is a weekday (or a weekend) and turns them off at the next occurrence of STOP TIME. The other three modes turn the outputs on if the gas concentration indicated by that type of sensor is at or above the Rising Trip Point and turns the outputs off if the concentration is less than or equal to the Falling Trip Point.

4.8.7.3 Timed Day Selection

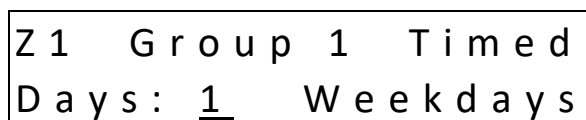

Figure 4-53 Timed Days Selection

Valid entries are:

- 1 - Weekdays, Monday thru Friday, (default)
- 2 - Weekends, Saturday and Sunday

4.8.7.4 Start Time

```
Z 1   G r o u p   1   T i m e d
S t a r t   T i m e :   0 7 : 0 0
```

Figure 4-54 Start Time Selection

The start time is entered in 24-hour format and the default value is 07:00 (7:00 AM).

4.8.7.5 Stop Time

```
Z 1   G r o u p   1   T i m e d
S t o p   T i m e :   1 8 : 0 0
```

Figure 4-55 Stop Time Selection

The stop time is entered in 24-hour format and the default value is 18:00 (6:00 PM).

4.8.7.6 Sensor Selection

```
Z 1   G r o u p   1   N O 2
S e n s o r :   0 2 ,   0 4 ,   1 1
```

Figure 5-56 Sensor Selection

Sensors are included or removed from the group by entering the two-digit channel number. After a sensor is added or removed, the list will be re-sorted so it does not matter in which order the sensors are added or removed. The default is to include all sensors of the specified type.

When the first digit of a sensor number is entered (a leading zero must be entered if the number is less than ten), the display will prompt to Add or Remove a sensor from the group.

```
Z 1   G r o u p   1   N O 2
A d d / R e m o v e :   0
```

Figure 5-57 Add/Remove sensor prompt

When the second digit is entered, the sensor will be added or removed from the control group, provided the sensor is of the proper type, NO₂ in this example. If the sensor is of the wrong type, or an invalid sensor channel number is entered, the request will not be completed.

4.8.7.7 Rising Trip Point

```
Z 1   G r o u p   1   N O 2
R i s i n g :   2 . 5   p p m
```

Figure 5-58 Rising Trip Point Entry

The default rising trip points are:

Description	Carbon Monoxide	Nitrogen Dioxide	Combustible Gas	Ammonia	Hydrogen Sulfide	Refrigerants	Carbon Dioxide	Oxygen
Type	CO	NO ₂	EX	NH ₃	H ₂ S	REF	CO ₂	O ₂
Rising Level	35 ppm	2.5 ppm	10% LEL	25 ppm	8 ppm	100 ppm	1,000 ppm	20.3% v/v

4.8.7.8 Falling Trip Point

```
Z 1   G r o u p   1   N O 2
F a l l i n g :   1 . 0   p p m
```

Figure 4-59 Falling Trip Point Entry

The default falling trip points are:

Description	Carbon Monoxide	Nitrogen Dioxide	Combustible Gas	Ammonia	Hydrogen Sulfide	Refrigerants	Carbon Dioxide	Oxygen
Type	CO	NO ₂	EX	NH ₃	H ₂ S	REF	CO ₂	O ₂
Falling Level	15 ppm	1.2 ppm	5% LEL	10 ppm	3 ppm	50 ppm	800 ppm	20.6% v/v

4.8.7.9 Multiple Sensor Mode

```
Z 1   G r o u p   1   N O 2
M o d e :   2   V o t i n g
```

Figure 4-60 Sensor Mode Selection

When multiple sensors are being monitored by a group, the output decision can be based on either voting, as shown here, or the average of all sensors in the group. Valid modes are:

- 1 - Average
- 2 - Voting (default)

When the configuration is Average, the gas concentrations from all sensors in the group are averaged and if the average is greater than or equal to the rising trip point the zone output(s) are activated. When the average is less than or equal to the falling trip point the zone output(s) are de-activated. If the average is between the two trip points, the outputs remain in their previous state.

When the configuration is Voting, the number of sensors in the group indicating a value greater than or equal to the rising trip point is counted. If the count is greater than or equal to the quorum then the zone output(s) are activated. If the count of sensors indicating less than or equal to the falling trip point is greater than or equal to the quorum the zone output(s) are de-

activated. Activating the output(s) is given priority if a group has an equal number of sensors with gas readings greater than or equal to the rising trip point and sensors with readings less than or equal to the falling trip point.

4.8.7.10 Multiple Sensor Quorum

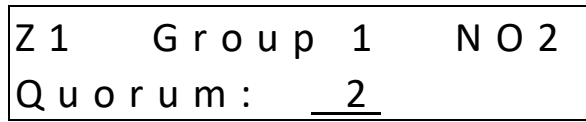

Figure 4-61 Quorum Entry

It is up to the installer to ensure that the quorum entry is appropriate for the configuration. Valid entries are one to twelve, but a value greater than the number of sensors being monitored by the group, stops the group from controlling the outputs. The default quorum value is 1.

4.8.8 Configure Signals Submenu

The DVP-120 can drive the buzzer, horn and strobe with different sound patterns to indicate the severity of the current conditions. These patterns are selectable by the installer using this group of submenus. Once again, the left and right keys will scroll through the signal types and the up and down keys will scroll to the signal sources.

4.8.8.1 Alarm Signal Summary

The alarm signals are in response to one or more sensors indicating gas levels at or above the sensors' configured alarm level.

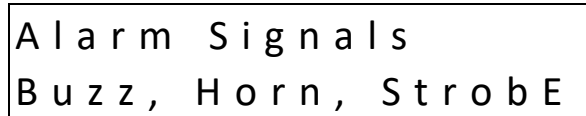

Figure 4-62 Alarm Signals

This display example shows that alarms are signaled by the internal buzzer, the external horn and the strobe.

4.8.8.2 Alarm Buzzer Signal

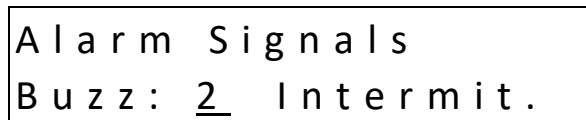

Figure 4-63 Buzzer Alarm Signal

This display example shows that the buzzer will signal an alarm condition with an intermittent signal. The signal definitions are:

- 1 - Continuous
- 2 - Intermittent, one second on at two second intervals (default)
- 3 - Double tap, two beeps at 5 second intervals
- 4 - Triple tap, three short beeps at 10 second intervals
- 5 - Off, buzzer will not sound

4.8.8.3 Alarm Horn Signal

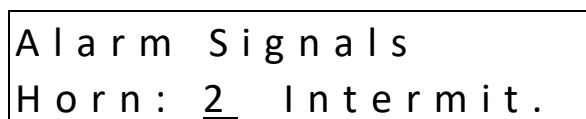

Figure 4-64 Horn Alarm Signal

This display example shows that the horn will signal an alarm condition with an intermittent signal. The signal definitions are:

- 1 - Continuous
- 2 - Intermittent, one second on at two second intervals (default)
- 3 - Double tap, two beeps at 5 second intervals
- 4 - Triple tap, three short beeps at 10 second intervals
- 5 - Off, horn will not sound

4.8.8.4 Alarm Strobe Signal

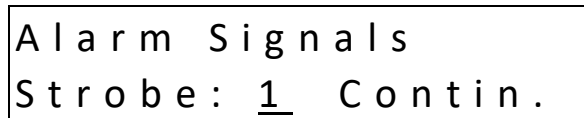

Figure 4-65 Strobe Alarm Signal

This display example shows that the strobe will signal an alarm condition with a continuous signal. The signal definitions are:

- 1 - Continuous (default)
- 2 - Intermittent, one second on at two second intervals
- 3 - Double tap, two beeps at 5 second intervals
- 4 - Triple tap, three short beeps at 10 second intervals
- 5 - Off, strobe will not flash

4.8.8.5 Warning Signal Summary

The warning signals are in response to one or more sensors indicating gas levels at or above the sensors' configured warning level.

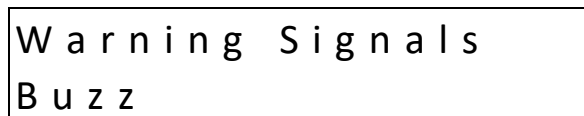

Figure 4-66 Warning Signals

This display example shows that warnings are signaled by the internal Buzzer only.

4.8.8.6 Warning Buzzer Signal

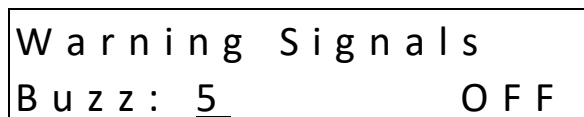

Figure 4-67 Buzzer Warning Signal

This display example shows that the buzzer will not signal a warning condition. The signal definitions are:

- 1 - Continuous
- 2 - Intermittent, one second on at two second intervals
- 3 - Double tap, two beeps at 5 second intervals
- 4 - Triple tap, three short beeps at 10 second intervals
- 5 - Off, buzzer will not sound (default)

4.8.8.7 Warning Horn Signal

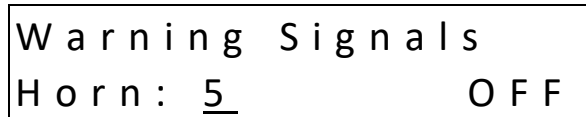

Figure 4-68 Horn Warning Signal

This display example shows that the horn will not signal a warning condition. The signal definitions are:

- 1 - Continuous
- 2 - Intermittent, one second on at two second intervals
- 3 - Double tap, two beeps at 5 second intervals
- 4 - Triple tap, three short beeps at 10 second intervals
- 5 - Off, horn will not sound (default)

4.8.8.8 Warning Strobe Signal

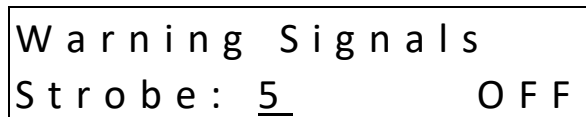

Figure 4-69 Strobe Warning Signal

This display example shows that the strobe will not signal a warning condition. The signal definitions are:

- 1 - Continuous
- 2 - Intermittent, one second on at two second intervals
- 3 - Double tap, two beeps at 5 second intervals
- 4 - Triple tap, three short beeps at 10 second intervals
- 5 - Off, strobe will not flash (default)

4.8.8.9 Trouble Signal Summary

The trouble signals are in response to one or more sensor faults, either as a defined current level, or because of wiring problems.

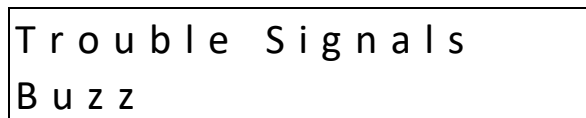

Figure 4-70 Trouble Signals

This display example shows that troubles are signaled by the internal buzzer only.

4.8.8.10 Trouble Buzzer Signal

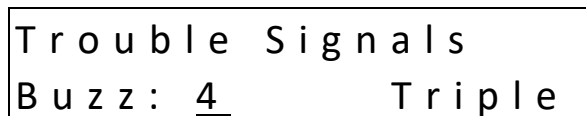

Figure 4-71 Buzzer Trouble Signal

This display example shows that the buzzer will signal a trouble condition with a triple tap signal. The buzzer signal definitions are:

- 1 - Continuous
- 2 - Intermittent, one second on at two second intervals
- 3 - Double tap, two beeps at 5 second intervals
- 4 - Triple tap, three short beeps at 10 second intervals (default)
- 5 - Off, buzzer will not sound

4.8.8.11 *Trouble Horn Signal*

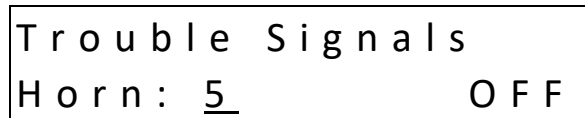

Figure 4-72 Horn Trouble Signal

This display example shows that the horn will not signal a trouble condition. The horn signal definitions are:

- 1 - Continuous
- 2 - Intermittent, one second on at two second intervals
- 3 - Double tap, two beeps at 5 second intervals
- 4 - Triple tap, three short beeps at 10 second intervals
- 5 - Off, horn will not sound (default)

4.8.8.12 *Trouble Strobe Signal*

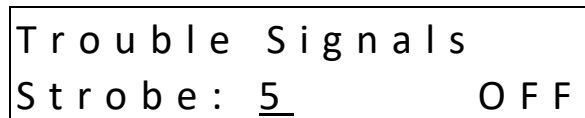

Figure 4-73 Strobe Trouble Signal

This display example shows that the strobe will not signal a trouble condition. The strobe signal definitions are:

- 1 - Continuous
- 2 - Intermittent, one second on at two second intervals
- 3 - Double tap, two beeps at 5 second intervals
- 4 - Triple tap, three short beeps at 10 second intervals
- 5 - Off, strobe will not flash (default)

5 Troubleshooting

The DVP-120 is tested at the factory for reliable operation. Most problems can be traced to the set-up of configurable features and modes, system wiring or trouble with the sensors.

5.1 System Status Light

The system status light (section 3 Operation) is normally green indicating power is present but will change to yellow whenever the controlling firmware detects a Trouble condition. Possible trouble conditions are:

- Any configured channel has less than 4 mA flowing in the current loop
- A sensor is reporting a trouble condition
- Any configured channel wiring is open.
- Internal controller board problems are detected.

5.1.1 Input Channel Trouble

Any time the POWER light is yellow, the first thing the technician should consider is that one of the input channels is in trouble. Reviewing the Sensor Status displays (using the up and down keys), should reveal which channel has a problem since the gas reading will be replaced with the word TROUBLE. Be sure that the 4-20mA output on each sensor is set to “On”.

5.1.1.1 No Sensor

A common source of a trouble condition is an input channel that is configured for a sensor that does not exist. In this case, the system expects to see current flowing within the current loop, but there cannot be current if there is no sensor connected. Either fix the miss-wired sensor, or change the sensor type to NONE, section 3.3.3.2. After returning to normal mode (using the MENU key), the power light should return to steady green. Be sure that the 4-20mA output on each sensor is set to “On”.

5.1.1.2 Wrong Sensor Type

If all channels are configured properly, another source a trouble condition could be the type of sensor attached to an input channel. Macurco™ Toxic sensors can indicate high gas concentrations with signals of up to 24 mA in the current loop. However, a combustible sensor can indicate a trouble condition with a 21-mA signal. Therefore, a toxic sensor connected to channel which is configured for a combustible sensor can cause a fault indication if the gas concentration is high enough.

5.1.1.3 Sensor Trouble

All Macurco™ Sensors are either supplied with a STATUS lamp that will indicate the health of the device or will display a trouble condition on the digital display. Macurco sensors may be tested by depressing the TEST button on the sensor printed circuit board, or (depending on the type of sensor), the button on the interior front panel of the unit. Macurco sensors will step the output current level from 4 mA to 20 mA over the course of the warm-up period, allowing the technician to determine where the trouble condition exists. If the sensor is still in a trouble condition, resetting the power may clear the trouble condition. Remove one of the power wires from the sensor terminal strip causing the sensor to go through a power-up reboot. Be sure that the 4-20mA output on each sensor is set to “On”.

5.1.1.4 Faulty Wiring

Finally, the wiring between the DVP-120 and the sensor should be investigated. The power input to the sensor should be investigated at the sensor. Since Macurco sensors are rated for operation between 12 and 24 VDC or VAC, the voltage drop between the DVP-120 and the sensor should not be an issue if the wiring guidelines in Table 2-2 are followed. A multi-meter can be inserted to check the current flow within the loop, or a continuity test can be performed on all four wires between the DVP-120 and the sensor. Ensure power is removed from the DVP-120 prior to removing the input or output connectors from the DVP-120 controller board. Be sure that the 4-20mA output on each sensor is set to “On”.

5.1.1.5 Resettable Fuse

Each sensor channel is provided with a PTC-resettable fuse internal to the DVP-120 to protect against over current situations. To reset a sensor channel, power should be removed from the channel. This can be accomplished by removing power from the sensor – causing the loop current to go to zero, or by completely removing power from the DVP-120.

5.1.2 Internal Controller board Trouble

If the sensor status display and investigative efforts reveal no problems with the input channel current loops and channel configuration, the most likely trouble condition is an internal problem detected by the DVP-120 controller. In this case, contact the Macurco Technical Service for advice and help.

5.2 Timed ventilation problem

When using the timed ventilation mode, the system clock should be checked regularly (at least twice a year). The battery backed real time clock in the DVP-120 does not adjust for daylight saving time so the spring and fall switch over points are good choices to check the system clock.

 WARNING
High voltage terminals (120/240 VAC) are located within the DVP-120, presenting a hazard to service technicians. Only qualified technicians should open the DVP-120 case and service the internal circuits. Ensure power is removed from the DVP-120 prior to servicing the unit.

5.3 No Power

The DVP-120 starts up as soon as power is applied to the microcontroller, and the DVP-120 is designed to have power continuously applied to the unit. An external indication of successful power application to the unit is the immediate operation of the Status Lamps grouped around the LCD. If the operator does not see immediate response from the status lamps, power should be checked at AC~

If the correct voltage is noted at AC~, then the internal fuse of the DVP-120 should be investigated. The DVP-120 is protected from over-current and transient situations by the fuse at F3. AFTER removing power from the DVP-120, F3 can be checked by removing the safety cover. If necessary, replace F3 with a 5x20 mm SLO-BLO fuse with a rating of 1 Amp 250V, e.g. Littelfuse P/N 218001. Be sure to REPLACE THE SAFETY COVER on F3 before re-applying power to the DVP-120.

 WARNING
DVP-120 may not function effectively below 32°F (0°C) or above 120°F (49°C). Using the equipment outside of this temperature range may adversely affect product.

5.4 LCD Display Unreadable

It is possible that the LCD is unreadable due to temperature or aging of the control panel. If this is the case the following steps should rectify the problem:

- Hold the MENU key for three (3) seconds. After three seconds, the power led will turn red. After two additional seconds, the LCD backlight will also be turned off.
- Press the UP and DOWN cursor keys to change the LCD contrast. Each press of the UP or DOWN cursor key will change the contrast by a step in that direction. Adjust the contrast for best viewing.
- Press any other key to exit the contrast-setting mode.

5.5 Keypad does not respond

The keypad can be unlocked by holding the zero (0) key for 3 seconds. At this time the backlight will turn on and the display will return to normal mode. The keypad can again be locked by holding the zero key for 3 seconds, until the display shows KEYS LOCKED.

5.5.1 After silencing Alarm, Warning or Trouble

LCD continues to show the alarm, warning or trouble message.

It is possible that the horn or strobe have been configured to respond in alarm, warning or trouble conditions, even though there is no horn or strobe connected (or perhaps they are used for some purpose that is not audible or visible). First, hold the HUSH key for five seconds, or until the display changes to “ALARM silenced for 5 minutes” or another relevant message. Second, use the configuration menu to disable the horn or strobe, if they are not being used for some other purpose.

5.6 Power Failure

After any power failure, the user should check the system clock. While system parameters are maintained in memory, the system clock is backed-up by a limited-capacity button cell battery.

6 Testing & Maintenance

Macurco recommends performing the DVP Functionality Test at least once a year.

6.1 Testing

6.1.1 Keypad Test

1. Power down the DVP-120.
2. Remove the Jumper Shorting Connector from the EXT header and place the Jumper Shorting Connector onto the top two pins of the SYS header.
3. Power up the DVP-120 and close the panel door. The LCD will display “Current Password #####” for 3 seconds (where ##### is the current set password) then will display “V24 =##. #-OK”, where V24 is the expected Power Supply output voltage and the ##.# is the actual Power Supply output voltage. If the status is OK, then proceed to the test process by pressing 0 key.
4. Read and follow the instruction on the LCD to test the keypad. When finished, the LCD will display “Keypad Test OK 0-Control Buzzer”.
5. Press 0 key to test the buzzer. You will hear the buzzer sound. To turn off the sound, press the 0 key again.
6. When the keypad test has passed, and the buzzer sound is good, turn off the power of the DVP-120.
7. Remove the jumper shorting connector from SYS header and install onto the two bottom pins of EXT header marked +24V.
8. Turn ON the DVP-120 and it should operate as explained in section [4.2 Initial Operating Mode](#).

6.1.2 Functionality Test

1. Turn off the DVP-120.
2. For DVP-120 move the jumper from bottom two pins of EXT connector to pins 1 and 2 of EXT connector. For DVP-120, move the jumper in J10 to left two pins of J10.
3. Turn on the DVP-120.

Self-test is performed when the panel is powered on with a jumper in the position indicated in above step. A self-test pass is indicated by “Test Mode mm: ss – Press any key” on the LCD where “mm” are minutes and “ss” are seconds. Confirm “ss” is incremented every second.

4. Press following keys in the keypad to test corresponding functionality.

Key in Keypad	Functionality Test
0	Strobe
9	Horn
Menu	Relay 1
Hush	Relay 2
Up	Relay 3
Right	Buzzer

Table 7-1 Keypad keys for Testing Functionality

5. If all test is complete, turn off the DVP-120. Move the jumper back to bottom two pins of EXT connector for DVP-120.
6. Turn ON DVP-120 and verify the normal operation as explained in section [4.2 Initial Operating Mode](#).

6.2 Maintenance

DVP-120 do not have parts that require regular maintenance.

For fuse, replacement see Section [5.3 No Power](#) of the manual.

In the event of trouble or any kind of help and support contact Technical Support at 1-844-325-3050

7 Appendix A – Table of Figures

Figure 3-1 Mounting Holes	9
Figure 3-2 Typical Layout	9
Table 3-1 Main Power Connections	10
Figure 3-3 System Wiring Diagram	10
Figure 3-4 Sensor Interface Connection – Channels 5 and 6	11
Table 3-2 Recommended Wire Gauge	11
Figure 3-5 DVP-120 Internal View	12
Figure 3-6 Relay Connections	12
Figure 3-7 Horn & Strobe Connector	13
Table 3-3 Wire Gauge for Horn & Strobe Functions	13
Figure 4-1 Model Display	14
Figure 4-2 Warm-Up display	14
Figure 4-3 Keypad layout	15
Figure 4-4 Normal System Display	16
Figure 4-5 Sensor prompt	16
Figure 4-6 Alarm display	16
Figure 4-7 Alarm Silenced message	17
Figure 4-8 Warning display	17
Figure 4-9 Warning Silenced message	18
Figure 4-10 Trouble display	18
Figure 4-11 Trouble Silenced message	18
Figure 4-12 Zone Signal display	19
Figure 4-13 Zone Signal Silenced message	19
Figure 4-14 Hardware Summary	19
Figure 4-15 Save Configuration Prompt	19
Figure 4-16 Set Time of Day	20
Figure 4-17 Enter Hours	21
Figure 4-18 Enter Minutes	21
Figure 4-19 Set Day of the week	21
Figure 4-20 Load Default Configuration	22
Table 4-1 Default Type settings	22
Figure 4-21 Change Password	22
Figure 4-22 Configuration Changed	23
Figure 4-23 Configure Sensor	23
Figure 4-24 Sensor Definition	23
Figure 4-25 Sensor Tag	23
Figure 4-26 Sensor Units	24
Figure 4-27 Depletion Type	24
Figure 4-28 Decimal Points	24
Figure 4-29 Resolution	24
Figure 4-30 Sensor Range	24
Figure 4-31 Alarm Level	24
Figure 4-32 Warning Level	25
Figure 4-33 Rising Trip Point	25
Figure 4-34 Falling Trip Point	25
Figure 4-35 Enter Password	25
Figure 4-36 Password Prompt	25

Figure 4-37 Wrong Password Prompt..... 26

Figure 4-38 Sensor Summary 26

Figure 4-39 Sensor Type 26

Figure 4-40 Sensor Alarm Level 27

Figure 4-41 Sensor Warning Level 27

Figure 4-42 Sensor Range 27

Figure 4-43 Relay Summary 28

Figure 4-44 Relay Mode..... 28

Figure 4-45 Turn on Delay..... 28

Figure 4-46 Minimum on Time 28

Figure 4-47 Horn Summary 29

Figure 4-48 Horn Minimum on Time 29

Figure 4-49 Strobe Summary 29

Figure 4-50 Strobe Minimum on Time..... 29

Figure 4-51 Zone Controls..... 30

Figure 4-52 Zone Group Type 31

Figure 4-53 Timed Days Selection..... 31

Figure 4-54 Start Time Selection..... 32

Figure 4-55 Stop Time Selection 32

Figure 5-56 Sensor Selection 32

Figure 5-57 Add/Remove sensor prompt 32

Figure 5-58 Rising Trip Point Entry..... 33

Figure 4-59 Falling Trip Point Entry..... 33

Figure 4-60 Sensor Mode Selection 33

Figure 4-61 Quorum Entry 34

Figure 4-62 Alarm Signals 34

Figure 4-63 Buzzer Alarm Signal 34

Figure 4-64 Horn Alarm Signal 34

Figure 4-65 Strobe Alarm Signal 35

Figure 4-66 Warning Signals 35

Figure 4-67 Buzzer Warning Signal 35

Figure 4-68 Horn Warning Signal..... 36

Figure 4-69 Strobe Warning Signal 36

Figure 4-70 Trouble Signals..... 36

Figure 4-71 Buzzer Trouble Signal..... 36

Figure 4-72 Horn Trouble Signal 37

Figure 4-73 Strobe Trouble Signal..... 37

Table B-1 Default settings..... 45

Figure B-1 System Wiring Diagram 45

Figure B-2 Hardware Summary..... 46

Figure B-3 Keypad Layout 46

Figure B-4 Save Configuration Prompt 46

8 Appendix B – Quick Setup

IMPORTANT: To properly and effectively program the system you must configure the Sensors, Relays, Zones, and Signals. If the user has not entered any parameters, the system WILL NOT be monitoring the sensors or controlling the ventilation system. The relays will be in the not actuated state and the horn and strobe outputs will be off. Be sure that the 4-20mA output on each sensor is set to “On”.

1. **Configure System:** allows the installer to set the time of day, the day of the week, load the default configuration, configure custom sensors and change the password.
2. **Configure Sensors:** defines the Sensor type – CO, NO₂, or None and sets Alarm Level, Warning Level, and Sensor Range
3. **Configure Relays, Horn and Strobe:** defines operation as Normally Off or On, Delay Time, Minimum Runtime – this applies to all three relays as well as the horn and strobe.

Note: The Delay Time default is 1 minute. If the duration of a test procedure or gas exposure is less than 1 minute, the relays, horns, and strobes may not engage even though the DVP-120 display and the sensors respond. When testing the system disable the delay (set Delay Time to zero minutes/seconds).

4. **Configure Zones:** defines Sensor Input & Relay/Alarm Output and sets up the sensor Groups (set of sensors of the same type and output within the same zone) - Sensor type, Sensor Number, Rising Trip point and Falling Trip point
5. **Configure Signals:** defines the output of the Alarm, Warning and Trouble Signals (Buzzer, Horn and Strobe) as On, Off, Intermittent, Continuous, etc.

Note 1: The default Password is 1234. If the password has been changed and/or lost:

- Power down the unit. Remove the Jumper Shorting Connector from the EXT header and place it on the top two pins of the SYS header.
- Power up the DVP-120. The first display is the current password on the unit.
- Power down the unit. Remove the Jumper Shorting Connector from the SYS header and place it back onto the two bottom pins of the EXT header.

Note 2: When entering multiple digit values the Up arrow (↑) acts as an enter key and it is not necessary to enter all allowed fields. Any other key is ignored or cancels the current parameter change.

Note 3: The MENU key will cause the system to shift to the Configuration Menu. The up and down and left and right arrow keys will scroll through all configuration parameters.

Default Configuration:

- Password 1234
- Sensors Undefined
- Alarm signals Buzzer = Intermittent, Horn = Intermittent, Strobe = Continuous
- Warning signals Buzzer = Off, Horn = Off, Strobe = Off
- Trouble signals Buzzer = Triple Tap, Horn = Off, Strobe = Off
- Relay 1 Normally off, 1-minute turn on delay, 1 minute minimum on time
- Relay 2 Normally off, 1-minute turn on delay, 1 minute minimum on time
- Relay 3 Normally off, 1-minute turn on delay, 1 minute minimum on time
- Horn Normally off, 1-minute turn on delay, 0 (zero) minimum on time
- Strobe Normally off, 1-minute turn on delay, 0 (zero) minimum on time
- Zone1 Controls R1
- Zone2 Controls R2
- Zone3 Controls R3
- Group 1 Type 1 CO, Voting mode, Quorum = 1

Macurco DVP-120 Operation Manual

- Group 2 Type 2 NO₂, Voting mode, Quorum = 1
- Group 3 Type 3 EX, Voting mode, Quorum = 1
- Group 4 Type 4 NH₃, Voting mode, Quorum = 1
- Group 5 Type 5 H₂S, Voting mode, Quorum = 1
- Group 6 Type 6 REF, Voting mode, Quorum = 1
- Group 7 currently unused
- Group 8 Type 8 O₂, Voting mode, Quorum = 1
- Group 9 Type 9 CO₂, Voting mode, Quorum = 1

Description	Carbon Monoxide	Nitrogen Dioxide	Combustible Gas	Ammonia	Hydrogen Sulfide	Refrigerants	Carbon Dioxide	Oxygen
Type	CO	NO ₂	EX	NH ₃	H ₂ S	REF	CO ₂	O ₂
Range	200 ppm	20 ppm	50% LEL	100 ppm	50 ppm	1,000 ppm	5,000 ppm	25% v/v
Alarm Level	200 ppm	5 ppm	20% LEL	75 ppm	20 ppm	300 ppm	4,000 ppm	19.5% v/v
Warning Level	100 ppm	3 ppm	15% LEL	50 ppm	14 ppm	200 ppm	1,500 ppm	20.0% v/v
Rising Level	35 ppm	2.5 ppm	10% LEL	25 ppm	8 ppm	100 ppm	1,000 ppm	20.3% v/v
Falling Level	15 ppm	1.2 ppm	5% LEL	10 ppm	3 ppm	50 ppm	800 ppm	20.6% v/v

Table B-1 Default settings

Typical coverage for CO, and NO₂ sensors is 5,000 sq. ft. (464.5 sq. m) (see the User Instructions for each sensor type for location and coverage details). Extra sensors may be needed near areas where people work, such as toll booths. Macurco provides only the control panels and sensors. Fans, relays, and other devices are provided by the contractor. See the appropriate building code for the size of fans and air changes per unit of time.

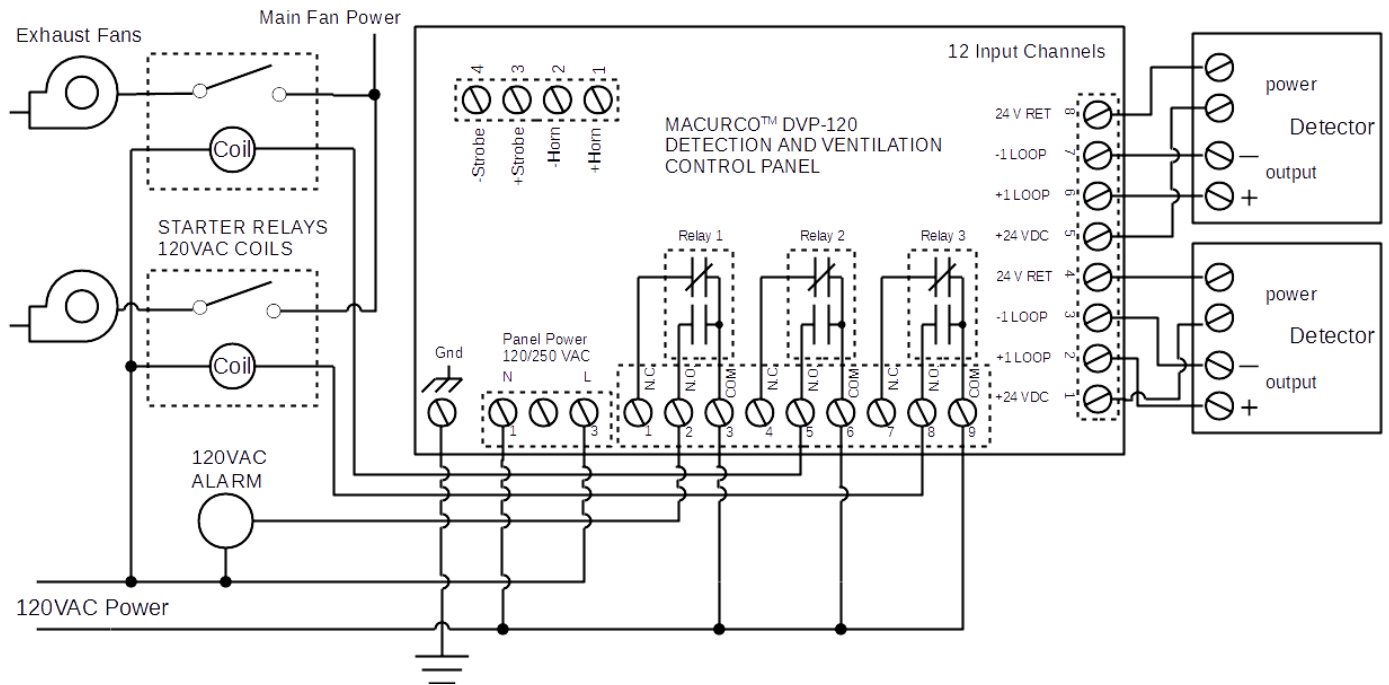

Figure B-1 System Wiring Diagram

Setting the System Configuration

The configuration menus can be entered from normal mode by pressing the MENU key. While in configuration mode, the user can review all configuration parameters to check the current operating conditions.



Figure B-2 Hardware Summary

The MENU key is also used to return to a higher-level menu, exit the configuration menus and finally return to normal mode.



Figure B-3 Keypad Layout

When exiting from the menu system to normal mode, if any configuration changes have been made, the panel will ask whether changes are to be saved.

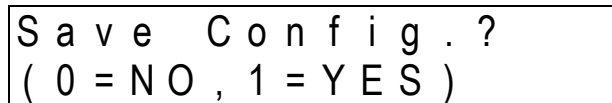

Figure B-4 Save Configuration Prompt

Pressing the zero (0) key at this point will cancel all changes except time and day of the week. Pressing the one (1) key will save all changes to memory, and the changes will then become immediately effective in controlling the ventilation system.

The numeric keys are used to change the particular parameter displayed. The underlined numeral, or space, on each display, indicates what will be changed by the numeric keys. The left and right arrow keys will enter the particular submenu and scroll through the items of the same type where appropriate, (e.g., enter the Configure Sensors submenu) and scroll through the parameter lists for the existing sensors. The up-arrow key scrolls through the menu entries in the order listed here, while the down arrow key scrolls in the reverse order.

Changing the configuration parameters requires the entry of a password before changes can be made. The default password is 1234.

In many cases, the parameter is entered as a string of numerals, but some parameters are selected by pressing a single key, e.g. pressing 1 selects Monday, 2 selects Tuesday, etc.

8.1 Configure System Submenu

8.1.1 Set Time of Day

The system configuration submenu provides entries to:

1. Set the time of day, 24-hour format
2. Set the day of the week, day 1 is Monday
3. Load Default Configuration
4. Change Password

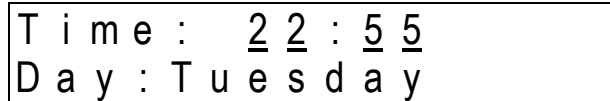

Time : 2 2 : 5 5
Day : T u e s d a y

Figure B-5 Set Time of Day

This display example shows that the time is 22:55 (10:55 PM). The underlined numerals indicate that the numeric keys can be used to set the current time of day. When the first numeral is entered (and after the password is entered if required), the display will change to show that the hour portion of the time is currently being entered.

Note that the time is saved as soon as the fourth numeral is entered.

8.1.2 Set Day of Week

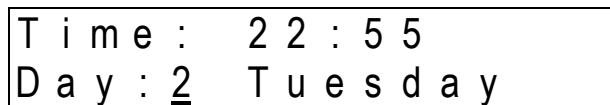

Time : 2 2 : 5 5
Day : 2 T u e s d a y

Figure B-6 Set Day of the Week

This display example shows that Tuesday is the current day of the week. The underlined numeral indicates that the day can be changed by entering the corresponding numeral: 1 Monday, 2 Tuesday, 3 Wednesday, 4 Thursday, 5 Friday, 6 Saturday, 7 Sunday

8.1.3 Load Default Configuration

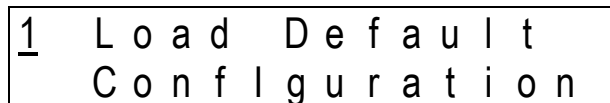

1 L o a d D e f a u l t
C o n f i g u r a t i o n

Figure B-7 Load Default Configuration

When the one (1) numeral is pressed, the panel will prompt for the password, even if it has been entered previously. If the password is entered correctly, the panel will overwrite the existing configuration with the default configuration. This operation is intended to restore the panel to a known basic condition if it is removed from one installation and installed in another.

8.1.4 Change Password

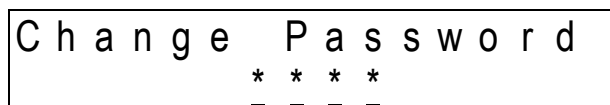

C h a n g e P a s s w o r d
* * * *

Figure B-8 Change Password

When the first digit is entered to change the password, the panel will prompt for the existing password to be entered (if it hasn't already been entered), see section [9.1.5 Enter Password](#) for more detail.

Once the current password has been entered, the panel will prompt for the new password.

8.1.5 Enter Password

If the password has not yet been entered, then when the first digit of any parameter is entered the panel will prompt for the current password. Note that the first digit entered is discarded; it does not count toward the password or toward the parameter entry.

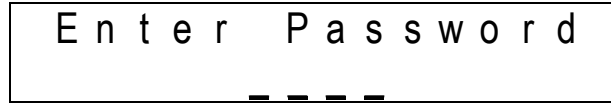

Figure B-9 Enter Password

If the password is not entered correctly the panel will display as follows:

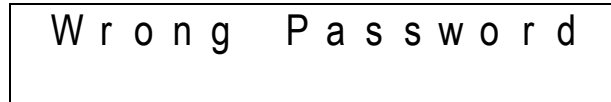

Figure B-10 Wrong Password Prompt

Once the current password has been entered, the panel will prompt for the configuration parameter being changed.

If the password has been lost:

- Power down the DVP-120
- Remove the Jumper Shorting Connector from the EXT header and place the Jumper Shorting Connector onto the top two pins of the SYS header.
- Power up the DVP-120. The first display is the current password on the unit.
- Remove the Jumper Shorting Connector from the SYS header and install back onto the two bottom pins of the EXT header.

8.2 Configure Sensors Submenu

8.2.1 See section [4.2 Initial Operating Mode](#) for more detail

8.2.2 See section [4.3 User Interface](#) for more detail

8.2.3 See section [4.13 System Configuration](#) for more detail

8.2.4 See section [4.13.3 Configure Sensors Submenu](#) for more detail

Press Menu to display Hardware Summary

↑ x 2 Configure Sensors

- Sensor

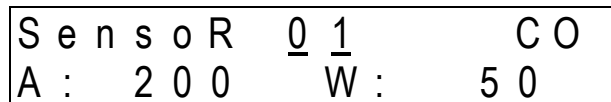

Figure B-11 Sensor Summary

↑ Sensor type (set sensor type)

1=CO, 2=NO₂, 3=EX, 4=NH₃, 5=H₂S, 6=REF, 7=CO₂, 8=O₂ and 0=None

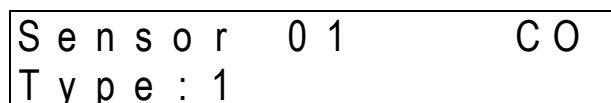

Figure B-12 Sensor Type

↑ Alarm Level - set level if needed, 0 = disable

```
S e n s o r   0 1       C O
A l a r m :           2 0 0 p p m
```

Figure B-13 Sensor Alarm Level

↑ Warning Level - set level if needed

```
S e n s o r   0 1       C O
W a r n i n g :       _ 5 0 p p m
```

Figure B-14 Sensor Warning Level

↑ Sensor Range - default range is in system

```
S e n s o r   0 1       C O
R a n g e :           2 0 0 p p m
```

Figure B-15 Sensor Range

↑ Next Sensor - complete for all sensor channels

8.3 Configure Relays, Horn & Strobe Submenu

8.3.1 See section [4.13.4 Configure Relays, Horn & Strobe Submenu](#) for more detail

Press Menu to display Hardware Summary

↑ x 3 Configure Relays

→ Relay 1

```
R e l a y   1   N o r m . O f f
D e l a y   0 N , M i n . O n
```

Figure B-16 Relay Summary

Default – Normally Off

```
R e l a y   1   N o r m . O f f
M o d e :   2
```

Figure B-17 Relay Mode

Default - Delay – 1 Minute

```
R e l a y   1   D e l a y   O n
( m m : s s )   0 1 : 0 0
```

Figure B-18 Turn on Delay

Default - Minimum Runtime - 1 Minute

```
R e l a y   1       M i n . O n
( m m : s s )   0 1 : 0 0
```

Figure B-19 Minimum on Time

→ Relay 2 - repeat for all relays, horn, and strobe

8.4 Configure Zones Submenu

8.4.1 See section [4.13.7 Configure Zones Submenu](#) for more detail

Definitions:

Zone – Defines Sensor Input & Relay / Alarm Output

Group – Set of Sensors of the same type and output within the same zone

Average – Activation based upon an average of sensors in a group

Voting – Number of sensors needed to be above trip point to activate the output

Quorum – Number of sensors need to vote, 1 = any sensor

Press Menu to display Hardware Summary

↑ x 4 Configure Zones

→ Zone 1 Controls

R_ R_ R_ H_ S_

Enter (underlined) number of outputs for zone

R = Relay (1, 2 and 3), H = Horn (4), S = Strobe (5)

```
Z o n e   1   C o n t r o l s
R 1  R 2  R 3  H 4  S 5
```

Figure B-20 Zone Controls

↑ Configure Group 1

Sensor type - enter #

1=CO, 2=NO₂, 3=Combustible, 0=None

```
Z 1   G r o u p   1           N O 2
S e n s o r   T y p e   : 2
```

Figure B-21 Zone Controls

↑ Sensor Number - enter a two-digit number for each sensor to be included in the group (e.g., 01, 02, 03...12.) from 01 through 12.

```
Z 1   G r o u p   1           N O 2
S e n s o r s   : 02 , 04 , 11
```

Figure B-22 Sensor Selection

↑ Rising (activation) Trip point

```
Z 1   G r o u p   1           N O 2
R i s i n g   :           2.5 p p m
```

Figure A-23 Rising Trip Point Entry

The default rising trip points are:

Description	Carbon Monoxide	Nitrogen Dioxide	Combustible Gas	Ammonia	Hydrogen Sulfide	Refrigerants	Carbon Dioxide	Oxygen
Rising Level	35 ppm	2.5 ppm	10% LEL	25 ppm	8 ppm	100 ppm	1,000 ppm	20.3% v/v

Table B-2 Default Raising trip points

↑ Falling (off) Trip point

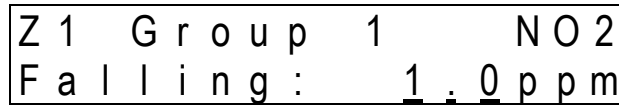

Figure B-24 Falling Trip Point Entry

↑ Average or Voting Mode

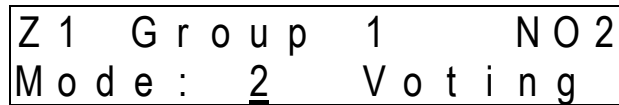

Figure B-25 Sensor Mode Selection

→ Configure Group 2 - repeat for up to three groups

When multiple sensors are being monitored as a Group, the DVP-120 output can be based on either sensor Voting (default) or the Average of all sensor readings in the Group.

When the configuration is Average, the gas concentrations from all sensors in the Group are averaged.

- If the average is greater than or equal to the rising trip point, the zone outputs are activated.
- If the average is less than or equal to the falling trip point, the zone output(s) is de-activated.
- If the average is between the two trip points, the outputs remain in their previous state.

When the configuration is Voting, the number of sensors in the Group indicating a value greater than or equal to the rising trip point is counted.

- If the count is greater than or equal to the Quorum (the minimum number of sensor votes in a Group needed) then the zone output(s) are activated.
- If the count of sensors indicating less than or equal to the falling trip point is greater than or equal to the Quorum the zone output(s) is de-activated.
- If a group has an equal number of sensors with gas readings greater than or equal the rising trip point and sensors with readings less than or equal to the falling trip point, activating the output(s) is given priority.

It is up to the installer to ensure that the Quorum entry is appropriate for the configuration. Valid entries are from one to twelve, but a value greater than the number of sensors being monitored by the group stops the group from controlling the outputs. The default Quorum value is 1; in this case, only 1 sensor vote is needed to control the output.

8.5 Configure Signals Submenu

8.5.1 See section [4.13.8 Configure Signals Submenu](#) for more detail

Press Menu to display Hardware Summary

↑ x5 Configure Signals

→Alarm Signals

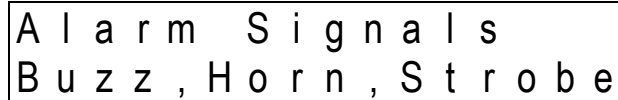

```
A l a r m   S i g n a l s
B u z z , H o r n , S t r o b e
```

Figure B-26 Alarm Signals

↑ Alarm Signal Buzzer (default 2 – Intermittent)

↑ Alarm Signal Horn (default 2 – Intermittent)

↑ Alarm Signal Strobe (default 1 – Continuous)

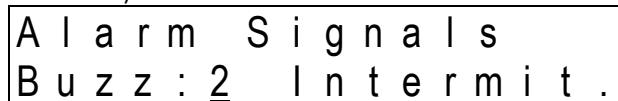

```
A l a r m   S i g n a l s
B u z z : 2   I n t e r m i t t .
```

Figure B-27 Buzzer Alarm Signal

↑ Warning Signals

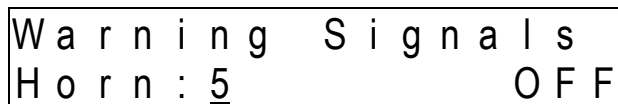

```
W a r n i n g   S i g n a l s
H o r n : 5           O F F
```

Figure B-28 Horn Warning Signal

↑ Warn Signal Buzzer (default 5 – Off)

↑ Warn Signal Horn (default 5 – Off)

↑ Warn Signal Strobe (default 5 – Off)

→Trouble Signals

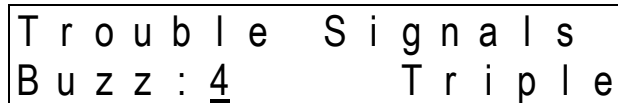

```
T r o u b l e   S i g n a l s
B u z z : 4           T r i p l e
```

Figure B-29 Buzzer Trouble Signal

↑ Trouble Signal Buzzer (default 4 – Triple Tap)

↑ Trouble Signal Horn (default 5 – Off)

↑ Trouble Signal Strobe (default 5 – Off)

9 Appendix C – Setup Record

Record network parameters and keep in a safe place to assist with installation and future troubleshooting will be simplified.

Date of Install: _____

Serial Number: _____

Location of Install: _____

Installed by: _____

Detectors / Sensors

Under Detector type record gas type (e.g. CM-6, TX-6-ND, OX-12) Note that CX-6 uses two addresses, one for each gas type.

Channel Address	Detector Type	Location	Zone Membership	
1				
2				
3				
4				
5				
6				
7				
8				
9				
10				
11				
12				

Relay connection	Connected device	Zone Configured	Delay	Runtime
Relay 1				
Relay 2				
Relay 3				
Horn 4				
Strobe 5				

Notes:

10 Appendix D – DVP-120 Quick Start Guide

Quick Start Guide for Adding Sensor to Zone: DVP-120 with 3 CO and 3 NO2 Detectors

Adding CO Sensors To A Zone:

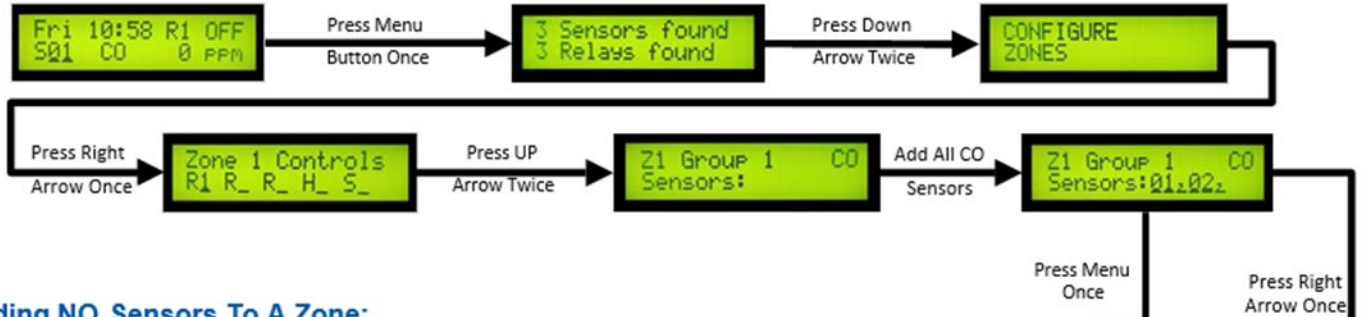

Adding NO₂ Sensors To A Zone:

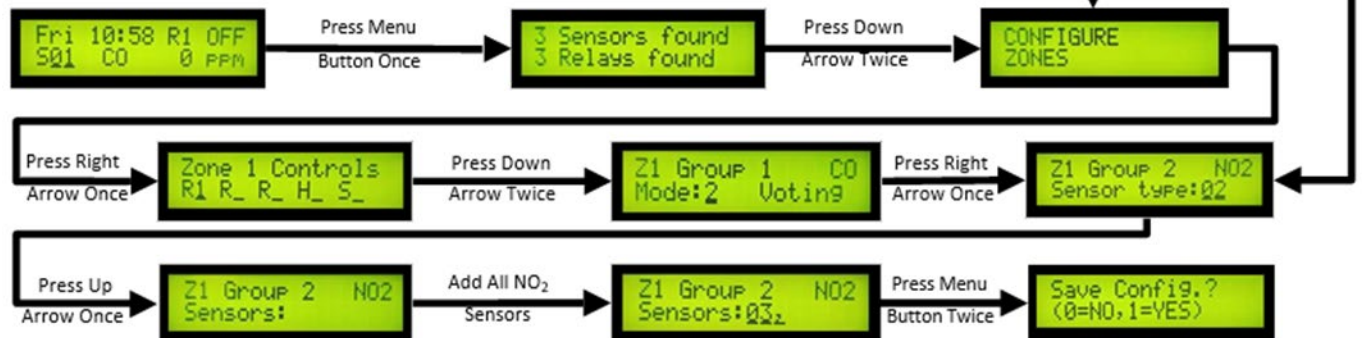

Remove the Startup Delay on Relays:



Run 420mA Current Loop Test:



11 Macurco Gas Detection Product limited warranty

Macurco warrants the DVP-120 gas detector will be free from defective materials and workmanship for a period of two (2) years from the date of manufacture (indicated on inside cover of the DVP-120), provided it is maintained and used in accordance with Macurco instructions and/or recommendations. If any component becomes defective during the warranty period, it will be replaced or repaired free of charge, if the unit is returned in accordance with the instructions below. This warranty does not apply to units that have been altered or had repair attempted, or that have been subjected to abuse, accidental or otherwise. The above warranty is in lieu of all other express warranties, obligations or liabilities. THE IMPLIED WARRANTIES OF MERCHANTABILITY AND FITNESS FOR PARTICULAR PURPOSE ARE LIMITED TO A PERIOD OF TWO (2) YEARS FROM THE PURCHASE DATE. Macurco shall not be liable for any incidental or consequential damages for breach of this or any other warranty, express or implied, arising out of or related to the use of said gas detector. The manufacturer or its agent's liability shall be limited to replacement or repair as set forth above. Buyer's sole and exclusive remedies are the return of the goods and repayment of the price, or repair and replacement of non-conforming goods or parts.

*Modbus is a trademark or registered trademark of Schneider Automation Inc.

*BACnet is a registered trademark of ASHRAE.

Macurco Gas Detection

3601 N. St. Paul Avenue
Sioux Falls, SD 57104

Technical Support Contact Information

Phone: 1-844-325-3050
Fax: 1-605-951-9616
Email: support@macurco.com
Website: www.macurco.com/support/

General Contact Information

Phone : 1-877-367-7891
Fax : 1-605-951-9616
Email: info@macurco.com
Website: www.macurco.com

REV – 2.0

Issue Date: 01-09-2020

Document No: 34-8708-4770-5

© Aerionics 2020. All rights reserved.

Macurco is a trademark of Aerionics, Inc.

