

MONOXIVENT®

Source Capture Systems

Operation and Maintenance Manual

Motor Hose Reel Installation Guide

9000-MTR / 9000-W-MTR



MONOXIVENT - SOURCE CAPTURE SYSTEMS

1306 Mill St., Rock Island, IL 61201
877-608-4383 - info@monoxivent.com
monoxivent.com

Mounting Hose Reel to Installed Unistrut

This page will guide you to mounting Hose Reels to Unistrut. This process and materials are for one hose reel. This process must be repeated for each Hose Reel mounted.

NOTE: Two pieces of Unistrut will need to be mounted for each Hose Reel, spaced accordingly to the four pre-drilled mounting holes in its frame.

1. Materials List

The following is a list of the necessary hardware. *(not included)*

Description	Quantity	
Unistruts (installed)	2	*Hose Reel mounting information detailed and shown is for reference only. Monoxivent is not responsible for any faulty mounting due to improper structural members. Monoxivent recommends using the services provided by a licensed structural engineer.
Channel Nuts	4	
Bolts	6	
Round Washers	4	
Lock Washers	4	
Square Washer s	4	

2. Location

Two pieces of Unistrut should already be mounted, based on the ceiling and spacing of the mounting holes that are pre-drilled into the Hose Reel steel frame. Four mounting holes are pre-drilled in each reel.

3. Lift

With the Unistrut installed in the correct position, lift the hose reel to its mounting level via a Cherry Picker or Scissor Lift that can support the weight, and move in place.

4. Bolts and Hardware

In each mounting hole, insert a threaded hex bolt, accompanied by a square washer, lock washer, and a round flat washer, into a channel nut. The lock washer should be closest to the head of the bolt, and the square washer against the Unistrut, with the round in the middle. Prior to tightening the reel to the Unistrut, verify hose reel A-frames are plumb and square. After hose reel is square and plumb, tighten hardware into the Unistrut channel nut. Re-check that reel remained plumb & square.

5. Repeat

This process and materials list should be repeated for each Hose Reel installation.

6. Inspection

Check that all hardware is tightened; the Hose Reel is in the correct location; and any push, pull, or lateral forces will not jeopardize the reels rigid mounting. Extract the hose from the reel to ensure the hose will reach all vehicles to be exhausted and reel the hose back on the drum to verify hose reel does not bind. If hose reel does bind verify A-frames are plumb and square.

Drawings on Next Page for Reference

Mounting Hose Reel to Installed Unistrut

The drawings below show several views and details of the Hose Reel Mounting. Spacing between Unistrut will vary per Hose Reel.

NOTE: Two pieces of Unistrut will be recommended for each Hose Reel. Connection to ceiling varies per building.

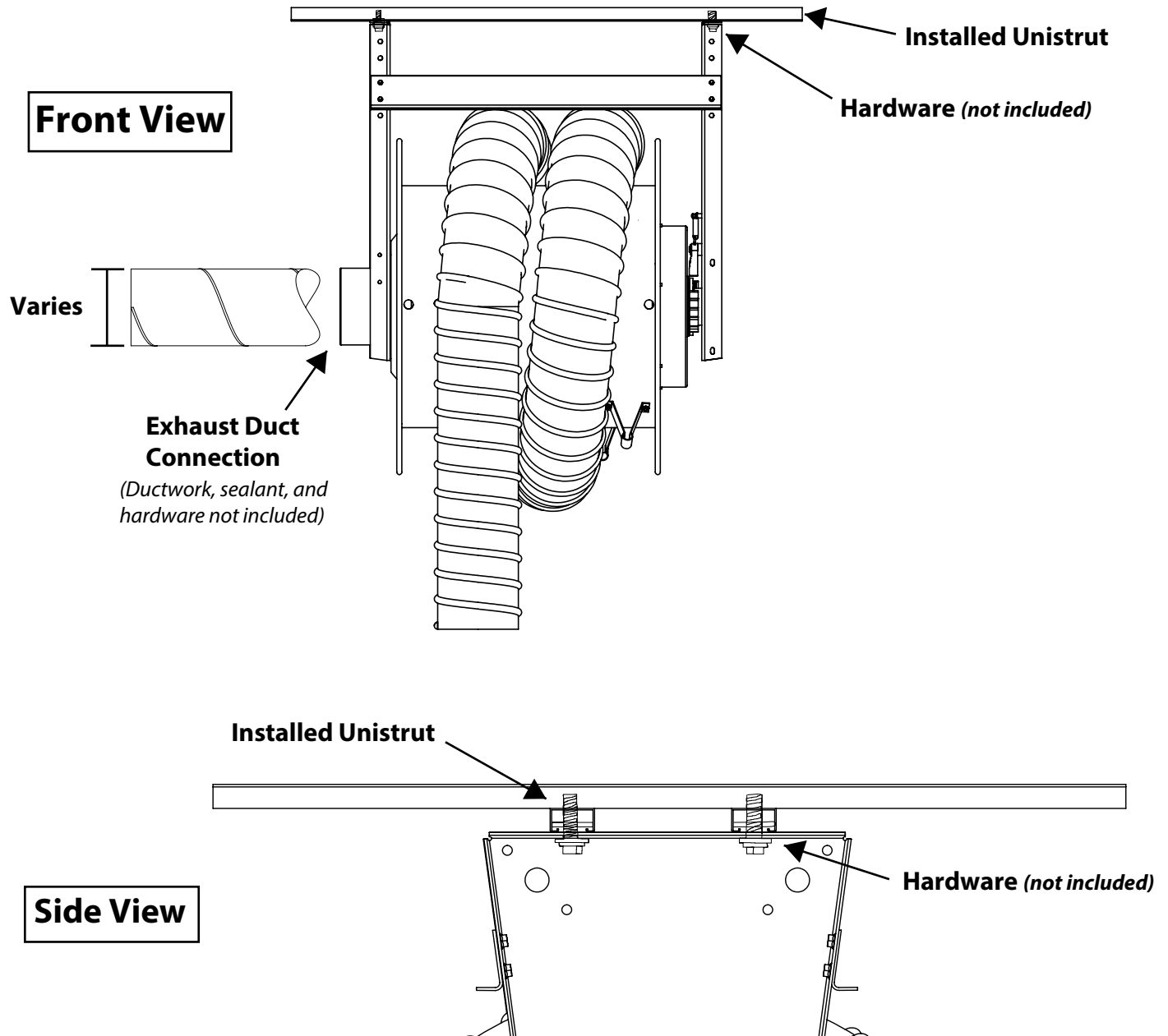

Dropping Hose Reel Elevation

Unistrut can be used to drop down one or both ends of the Hose Reel for sloped ceilings, tall ceilings, or obstructions

NOTE: Unistrut should already be secured to the Hose Reel, along the side of the reel, in line with it's pre-drilled mounting holes. (See next page drawings)

1. Measure

Determine the length of strut required for drop down. 1-5/8" strut is recommended. Lateral support will be fabricated at 45 degree angles. Lengths of strut may be different for each mounting location.

2. Attaching Strut

Strut should already be installed to the ceiling/roof. Secure the newly cut strut to the installed strut along the ceiling. This can be done with Unistrut fittings and hardware for strut.

3. Lifting Hose Reel

With the vertical strut attached to the ceiling, lift the reel up to the strut's height via Cherry Picker or Scissor Lift.

4. Attaching Hose Reel

With the same process as before, utilize 90 degree fittings for strut, or insert a channel nut into the strut, and secure a bolt into the reel side. Prior to tightening the reel to the Unistrut, verify the reel A-frames are plumb and square. Secure with a square No-Twist washer, lock washer, and Hex nut.

5. Lateral Support

The Hose Reel may need lateral support braces.

B. Decide where the lateral supports will connect to the ceiling. This will be different for each ceiling type. Generally, the hardware can either be installed into an additional short run of mounted Unistrut, directly bolted into the ceiling, or per the customers preference. This step will be custom for every application.

C. Measure, at a 45 degree angle, the distance from the leg to the mounting location of each lateral support. Cut 1" Unistrut to the desired length.

D. Two lateral supports should be used for each reel, opposite of the press and pull directions. A 45 degree angle should be used for best support.

6. Inspection

Check that all hardware is tightened; the Hose Reel is in the correct location; and any push, pull, or lateral forces will not jeopardize the reels rigid support. Verify that reel does not bind while extracting and retracting. If hose reel does bind verify A-frame's are plumb and square.

Drawings on Next Page for Reference

Adding Unistrut to Hose Reels

The drawings below show Unistrut installation for drop downs. Both front and side views are shown. Slanted ceilings can also be utilized with threaded rod. www.unistrut.us/

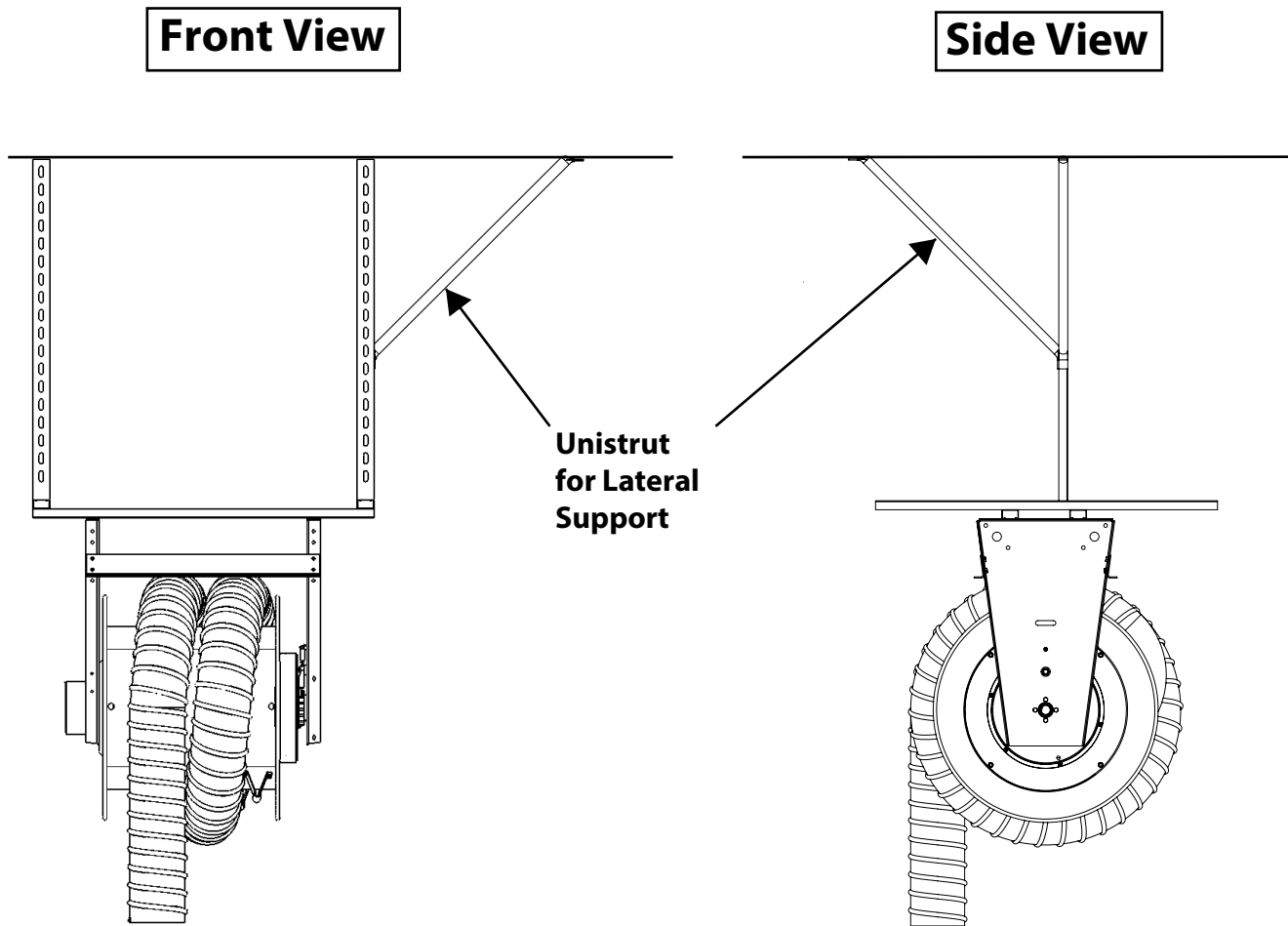

Mounting Hose Reels to Walls

This guide is only intended for suggestive means of mounting a Hose Reel to a wall. There is a large number of factors in wall strength, hose reel variance, and building conditions, please consult an expert to help decide if a mounting location is appropriate.

NOTE: Not all applications are the same. This guide assumes normal CMU or concrete block walls. I-Beams, wood stud, brick, and other mounting locations can work with proper hardware installation.

1. Measure

Obtain the wall thickness where the Hose Reel is to be mounted. Ensure the wall can handle the weight and pull/press forces from the reel. Actual Hose Reel weights available on request.

2. Unistrut

The wall must be sandwiched between four cut pieces of Unistrut; two on the interior and two on the exterior. The spans should be cut at least a few inches longer than the Hose Reel is wide. Make sure to note/mark the pre-drilled reel mounting hole locations.

3. Building Attachment

The cut Unistrut shall be installed horizontally with the flat ends against the wall surface. (*See drawings on next page*). A minimum of three wall penetrations per piece of Unistrut are required. Drill holes through the wall for installation.

4. Hardware

Using a cut threaded rod, long enough to fully penetrate the wall, affix the Unistrut, accompanied by a lock washer, flat washer, and a hex nut on each end. ensure the Unistrut is rigid. Wall sealants may be needed for the threaded rod

5. Attaching Hose Reel

In each mounting hole, insert a threaded hex bolt, accompanied by a square washer, lock washer, and a round flat washer into a channel nut. The lock washer should be against the head of the bolt, and the square washer against the Unistrut, with the round in the middle. Prior to tightening the reel to the Unistrut, verify hose reel A-frame's are plumb and square. Tighten this hardware assembly into the Unistrut channel nut.

6. Repeat

The previous process should be repeated for each Hose Reel. Ensure enough hardware is available for each installation.

7. Inspection

Check that all hardware is tightened; the Hose Reel is in the correct location; and any push, pull, or lateral forces will not jeopardize the reels rigid support. Verify that reel does not bind while extracting and retracting. If hose reel does bind verify A-frame's are plumb and square.

Drawings on Next Page for Reference

Mounting Hose Reels to Walls

Drawings show Hose Reel mounted to wall. Side Views, front views, and details shown.

Back View

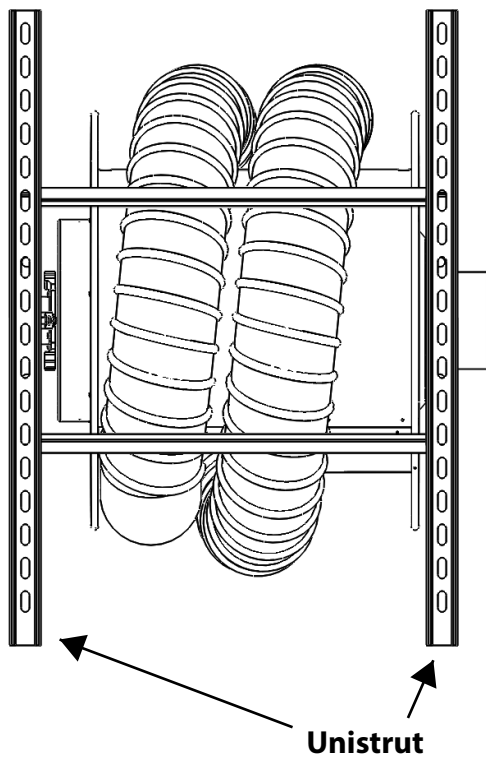

Side View

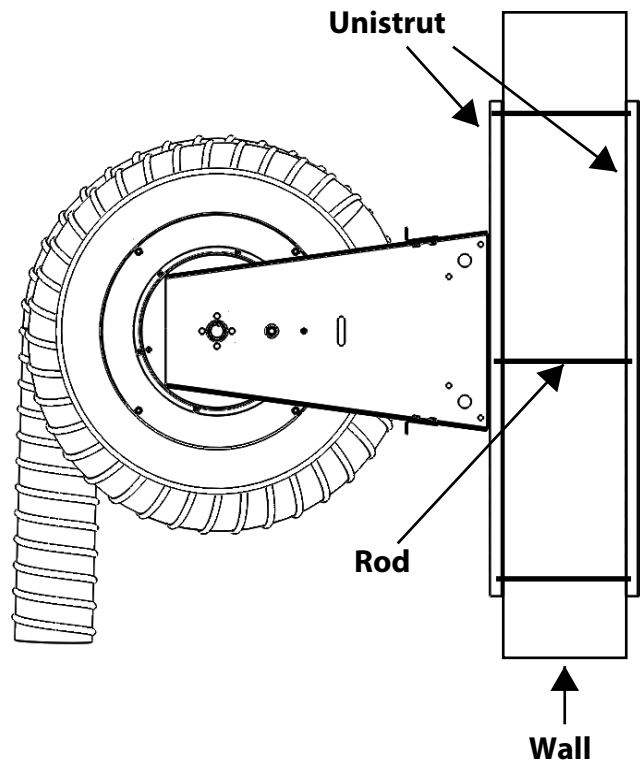

Hose Reel Hose Installation Procedure

1. Slide hose clamp over hose.



2. Slide hose over hose connection hub attached to reel. Make sure hose is fully engaged over hub.



Hose Reel Hose Installation Procedure

3. Slide clamp over hose/hose hub connection. Position clamp screw so that it is at either the 1:30 or 10:30 position relative to the top of the hose and securely tighten.



4. At approximately the 11:30 and 12:30 positions drill a 3/16" hole through the clamp, hose and hose connection hub.



Hose Reel Hose Installation Procedure

5. Through the two holes drive 1/4" self-tapping screws through the clamp, hose and hose connection hub.



DMS-HR Function

A hose reel may be supplied with an optional on/off toggle switch. This switch is referred to as a DMS-HR, meaning Direct Mount Switch on Hose Reel. See enclosed data on switch electrical characteristics.

The DMS-HR switch is acting only as an on/off control. The turning of the reel activates the actual switch. A pad strikes the toggle switch lever, which in turn, turns the switch on or off. The toggle switch allows current to pass through the switch or stops the current from passing through.

Normally an electrician will supply some sort of starter or control box for the fan on the reel. The fan could have either a tri-voltage 1 phase or 3 phase motor. In either case, the electrician should follow local code as to the type and need of the starter. The normal type starter usually consists of a NEMA box, contactor, overload, and maybe a transformer.

Keep in mind what the DMS-HR switch function is, simply to allow current to pass through the switch or to stop the current. Now the switch has limits as to the voltage that it can handle. (See DMS-HR specifications.) The switch can handle 120V, 24V, or 12V. These are common voltages used for the DMS-HR.

The starter, possibly by others, will have the components listed above. The electrician doing the wiring should know that there needs to be a wire, of proper gauge, run from the starter to the switch and back from the switch to the starter. The starter will receive its signal from the opening or closing of the DMS-HR switch on the reel through the means of the proper relay, contactor, or transformer within the starter. This electrical power running to the switch and back will then trigger the proper electrical component within the starter to close the contactor, which then runs power to activate the fan.

What the system is designed to do is start the fan automatically by pulling down the hose or to stop the fan by retracting the hose back onto the reel. Proper electrical components will run from the starter to the fan. The wiring of the DMS-HR simply activates the proper components within the starter to send power on to the fan. All wires can be run through the same proper conduit to handle the wires needed to provide electricity to the fan and switch from the starter.

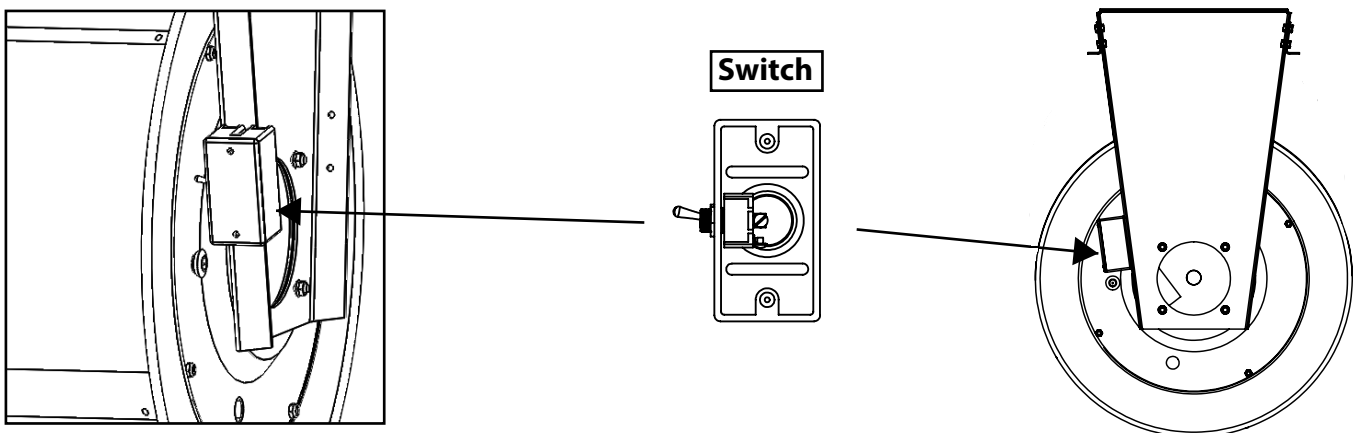

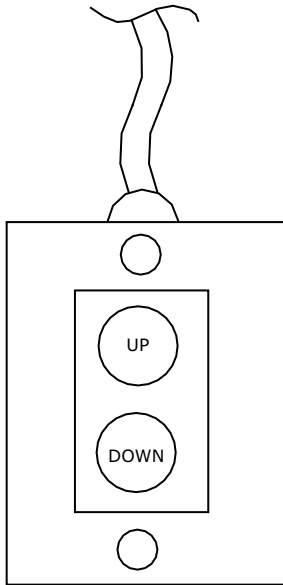

MONOXIVENT 2-BUTTON PENDULUM

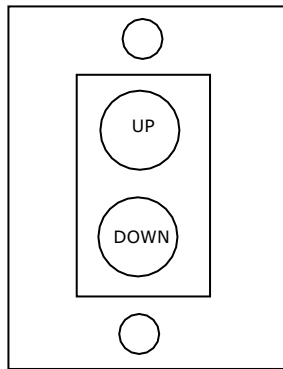

MONOXIVENT 2-BUTTON WALL/COLUMN MOUNT

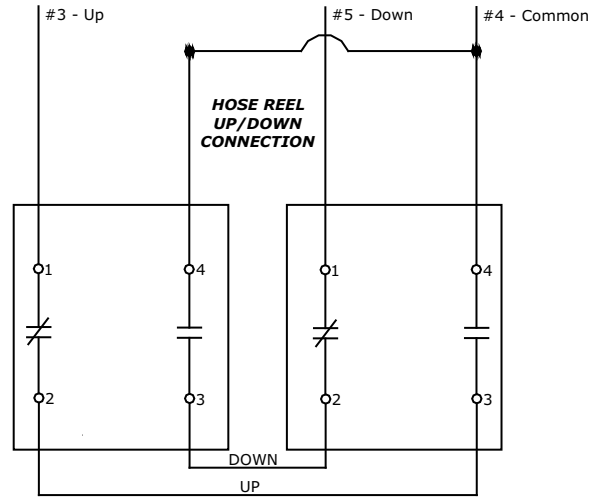

***Wiring to be done by a licensed electrician.**

2-Button Pendulum for “up/down” control of motorized hose reel.

Monoxivent will supply the buttons/switch, box cover, 20’ power cord (hanging pendulum only), strain relief fittings (hanging pendulum only), and junction box on hose reel (hanging pendulum only).

**MONOXIVENT 4-BUTTON HANGING PENDULUM, 4-BUTTON WALL/
COLUMN MOUNT & WIRING DIAGRAM**

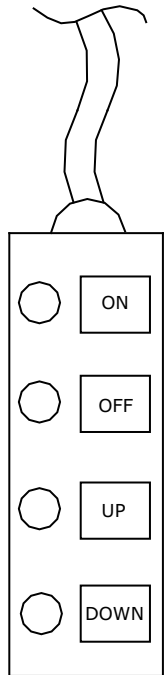
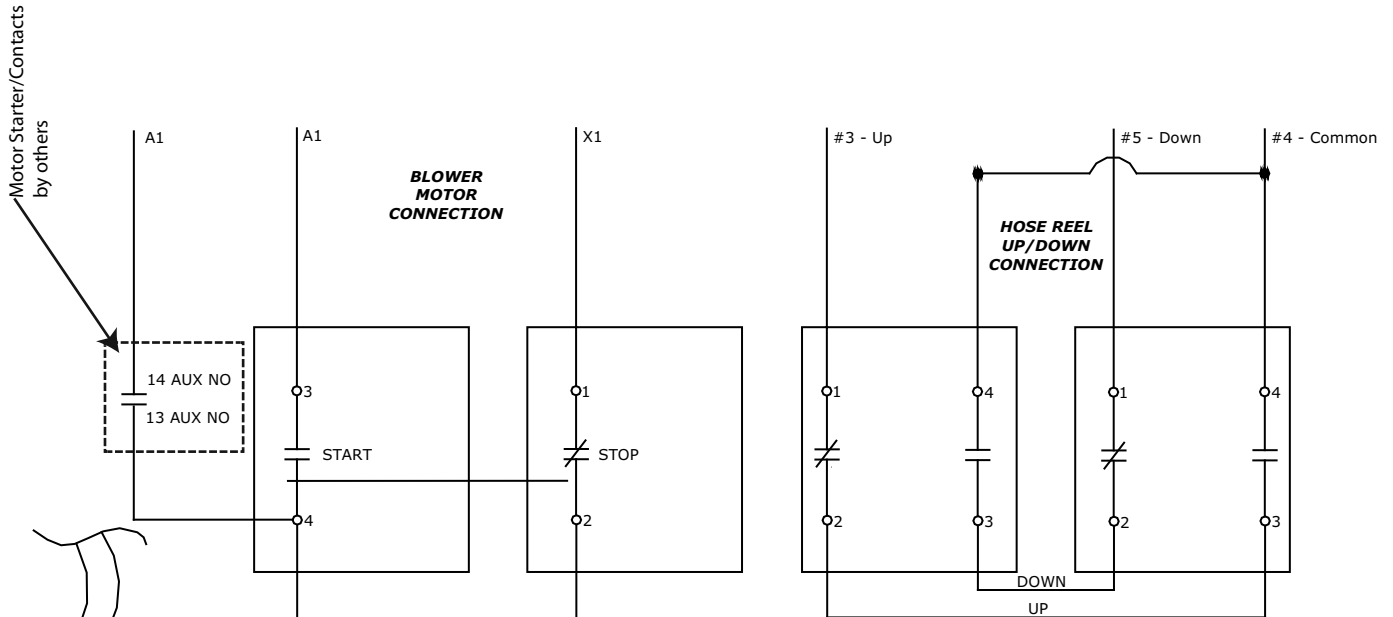

4-Button
Hanging
Pendulum

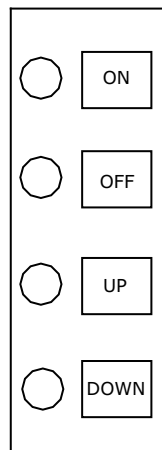

4-Button
Wall/Column
Mount

Displayed: the 4-button pendulum, 4-button wall/column mount (and wiring) for “up/down, on/off” control of motorized hose reel with push buttons.

Monoxivent will supply: the push buttons, cover box, 20’ power cord (hanging pendulum only), strain relief fittings (hanging pendulum only), and junction box.

***Wiring to be done by a licensed electrician.**

Direct Mount Fan to Hose Reel

****Please note that the hose reel supplied may have been designed to have a aluminum blower mounted directly to the side of the hose reel.**

If the reel is supplied for the direct mount fan, then the hose reel will have a heavy gauge steel four-(4) hole flange welded to the reel inlet. Shipped separately will be the fan. The fan will have a matching steel four (4)-hole flange with hardware and gaskets.

The mating flanges each have four (4) holes in a 90-degree position. Once the hose reel has been mounted securely, the fan can be bolted to the side of the reel.

Please note that the bolthole pattern is designed so the fan discharge can be positioned in one of the four angles. The fan discharge can be placed so it will face in a 12:00, 3:00, 6:00, or 9:00 position. The fan discharge is 6" diameter.

Discharge Duct Suggestions:

If the discharge-duct length from fan to exit point is 5' or less then the remaining hard duct shall be 6" I.D. If the discharge duct length will be longer than the 25', then come off the fan with a 6" to 8" transition and run the 8" duct to the exit point. This will relieve any additional static pressure on the discharge side of the fan.

Note: Be sure fan is bolted securely to the reel using the supplied hardware and gasketing.

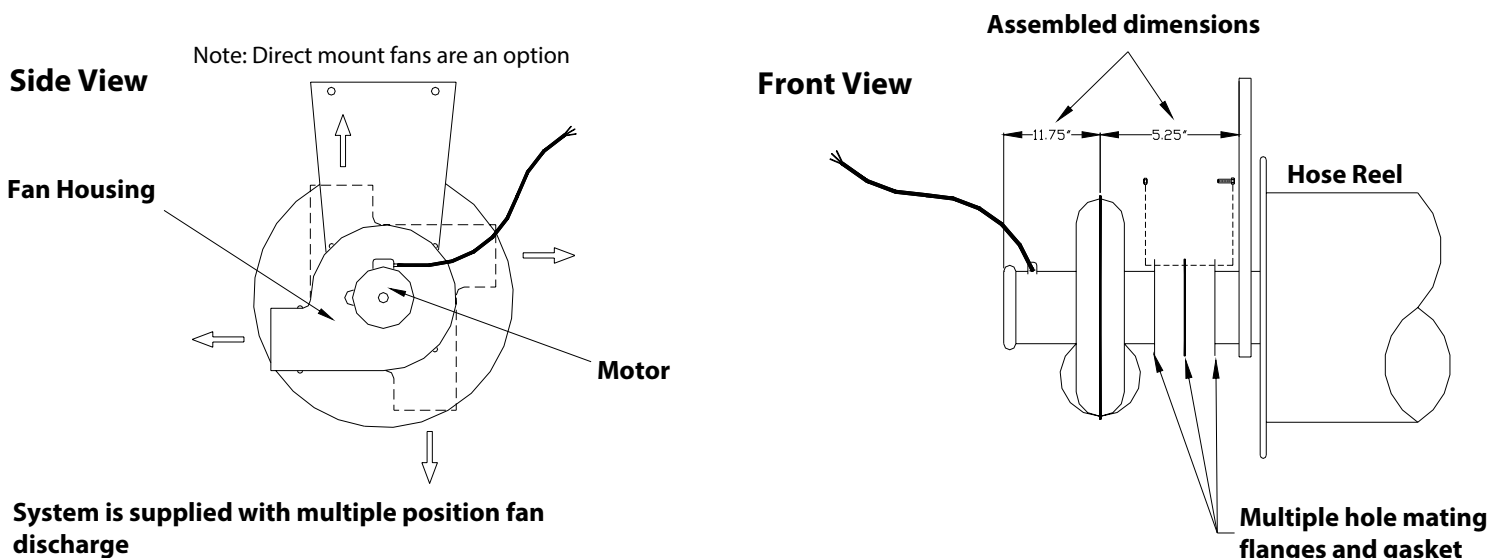

Exploded View

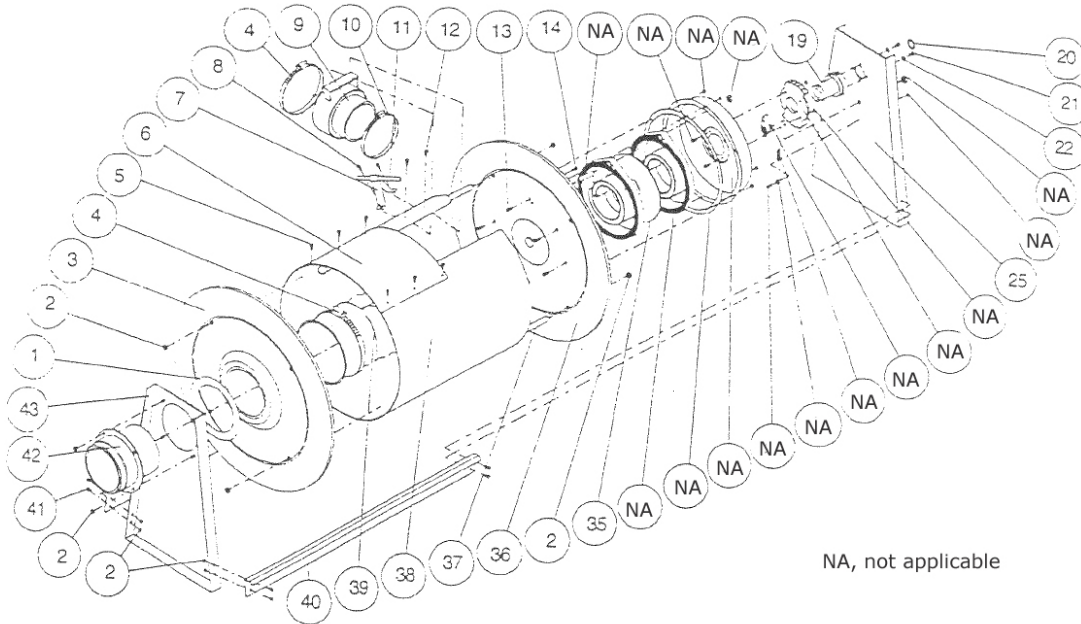

NA, not applicable

ITEM	PART #	QTY	DESCRIPTION	ITEM	PART#	QTY	DESCRIPTION
1	260166	1	Washer, Plastic	22	902016	4	Washer, Split Lock
2	300107	20	Nut, Lock (whiz) 5/16-18 Zinc	25	260746	1	Base (Right)
3	600317	1	Flange Assembly (left)	35	260165	1	Spacer, Spring
4	260186	2	Clamp Hose, 6"	36	600040	1	Flange Ass'y (Right)
5	S285-24	6	Screw, Self Taping 10-3/8"	41	S2-51	8	Screw, Hex Cap 5-16-18 x 1/2"
7	260178	2	Support, Guide	42	600312	1	Adapter Ass'y
8	S294-26	4	Screw, Self Drilling #10 x 1/2"	43	600314	1	Base Ass'y
11	260177-54	1	Tube, Guide				
12	300042	2	Screw, Self Tapping 10-24 x 1"				
13	300001	6	Screw, Machine 10-32 x 3/8"				
14	S294-26	1	Screw, Self Tapping #10 x 1/2"				
19	600531	1	Arbor, Assembly				
20	260176	1	Ring Retainer				
21	S56-41	4	Screw, Hex 1/4-20 x 1/2" GR5				

ITEM	DESCRIPTION	QTY	MODEL 604	MODEL 605	MODEL 606	MODEL 624	MODEL 625	MODEL 626	MODEL 634	MODEL 635	MODEL 636
6	Support Hose	1	260344	260344	260344	260748	260748	260748	260748	260748	260748
9	Reducer	1	260803	260804	260805	260803	260804	260805	260803	260804	260805
10	Clamp, Hose	1	260187-1	260555	260186	260187-1	260555	260186	260186	260186	260186
37	Rod Tie	4	260402-600	260402-600	260402-600	260402-700	260402-700	260402-700	260402-800	260402-800	260402-800
38	Spacer, Sheave	1	260173	260173	206173	260739	260739	260739	260772	260772	260772
39	Tube, Concnng.	1	260759-1	260759-1	260759-1	260759-1	260759-1	260759-1	260759-2	260759-2	260759-2
40	Brace, Cross	2	260574-3	260574-3	260754-3	260754-4	260754-4	260574-4	260574-5	260574-5	260574-5

9000-MTR Hose Reel Limit Setting Instructions

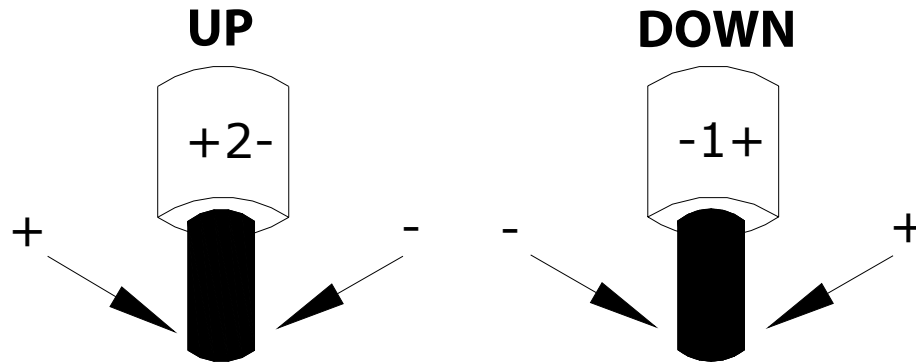

Motorized hose reel limits are preset in manufacturing, but may need to be readjusted for your application.

Adjust as follows. Adjust by turning black adjuster knobs with a 5/32" Allen wrench in direction needed. For example, if the hose needs to hang down from reel, run hose down to position need, and adjust knob #2 to the - direction until hose will stop automatically in the desired spot. A few minor adjustments will need to be done to position it exactly.

If the hose needs to be pulled up onto the reel further, adjust #2 knob to the + direction until hose is pulled up onto the reel as needed.

The down position knob #1 has been set in manufacturing to complete hang down for hose. No adjustment should be necessary.

If hose has been accidentally pulled off of the reel, or taken off, reinstall by turning reel in to full down position, reinstall hose, and lift hose back onto reel. Make sure hose clamps are tightened securely. Also, there is a manual override. Turn crank loop in case of power outage. Pull down and turn to operate.

PENDULUM SWITCH CONTROL

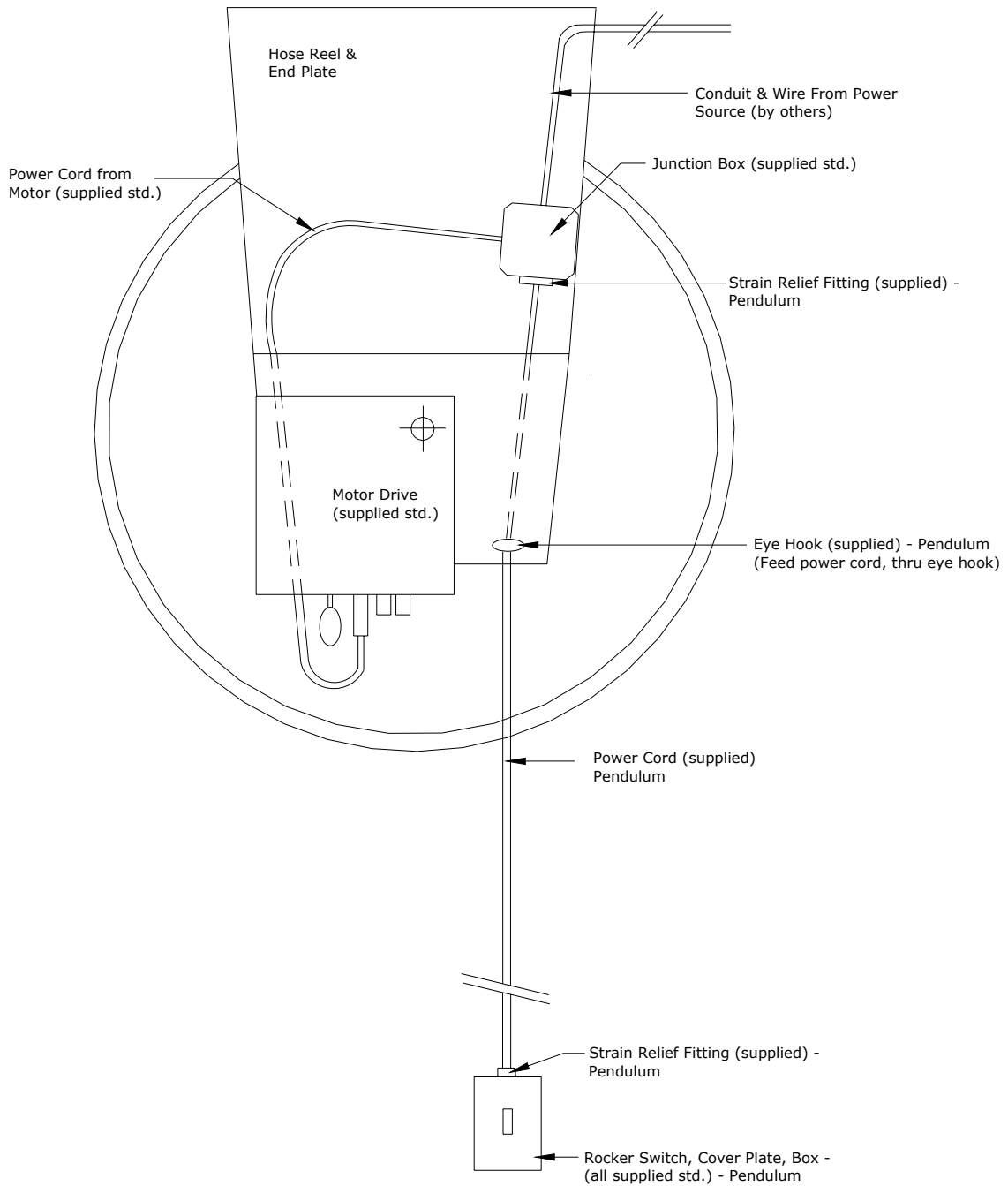

ON/OFF DMSHR SWITCH IS AN OPTION

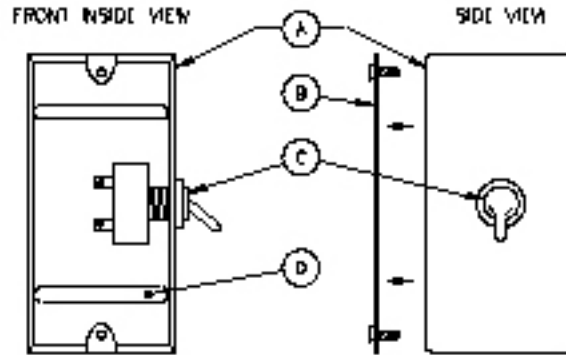

ON/OFF SWITCH ASSEMBLY MODEL ≠ DMSHR

VIEW
SWITCH ASSEMBLY MOUNTED
TO HOSE REEL

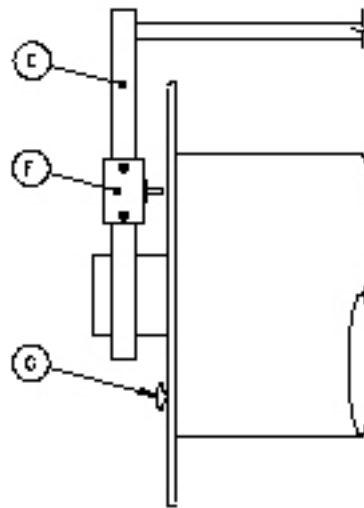

- A - Sealed Mounting Box
- B - Box Cover Plate
- C - On/Off Toggle Switch **
- D - (2) Slot Cuts for Adjustment of Box Depth Hose
- E - Reel Support Mounting Frame
- F - On/Off Switch Control Assembly
- G - Bumper Pad for Activating the On/Off Toggle

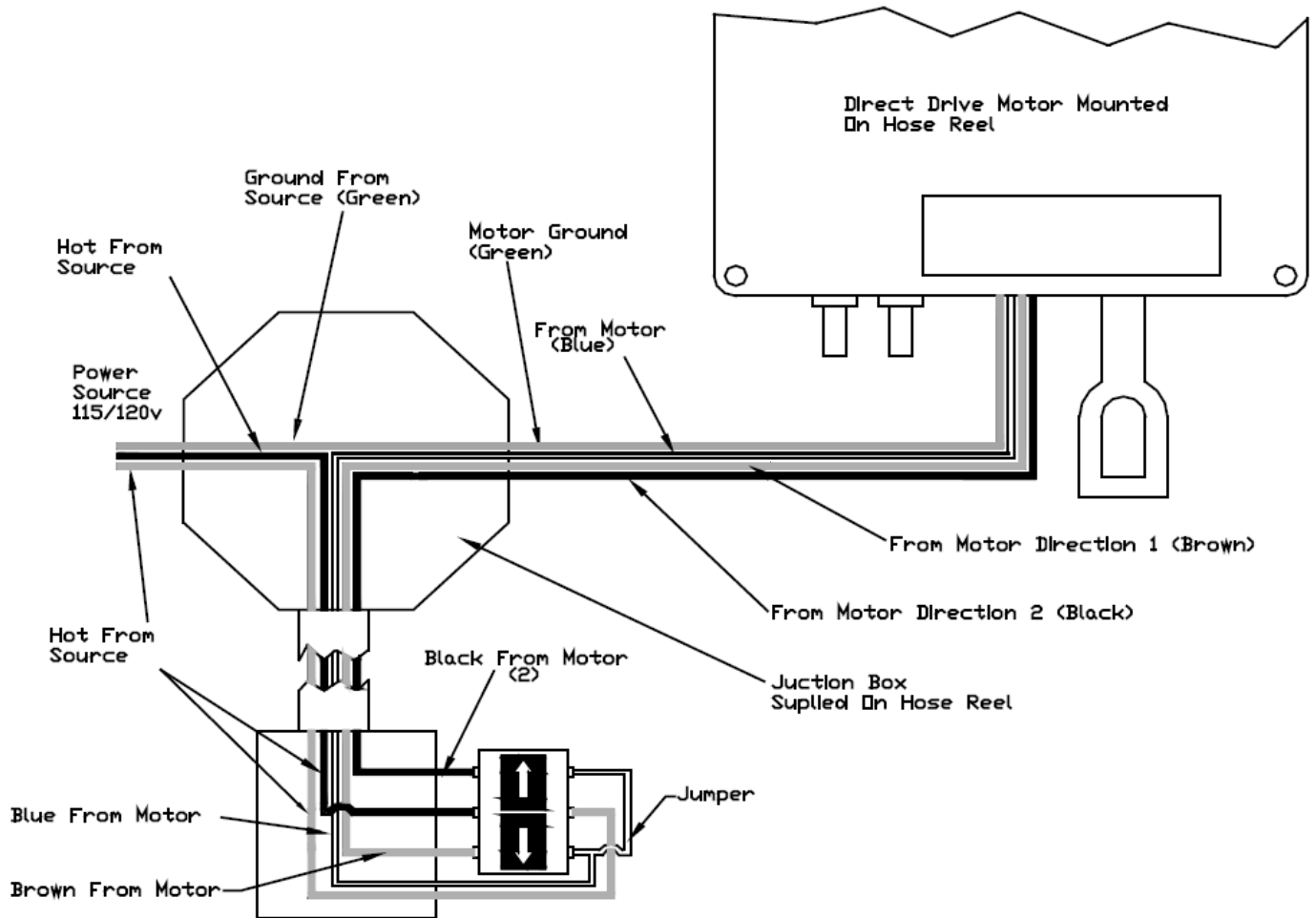

**220 VOLT SINGLE PHASE WIRING DIAGRAM.
ALL CONDUIT AND BOX FOR SWITCH - BY OTHERS.**

NOTE: The rocker switch may be set-up for a pendulum application. If a pendulum is desired, Monoxivent will supply the rocker switch, cover box, 20' power cord, strain relief fittings, and junction box on the hose reel.

NOTE: The wiring diagram, above, is for 220 Volt. Motors are available in 120 Volt. Please consult factory for wiring diagram.

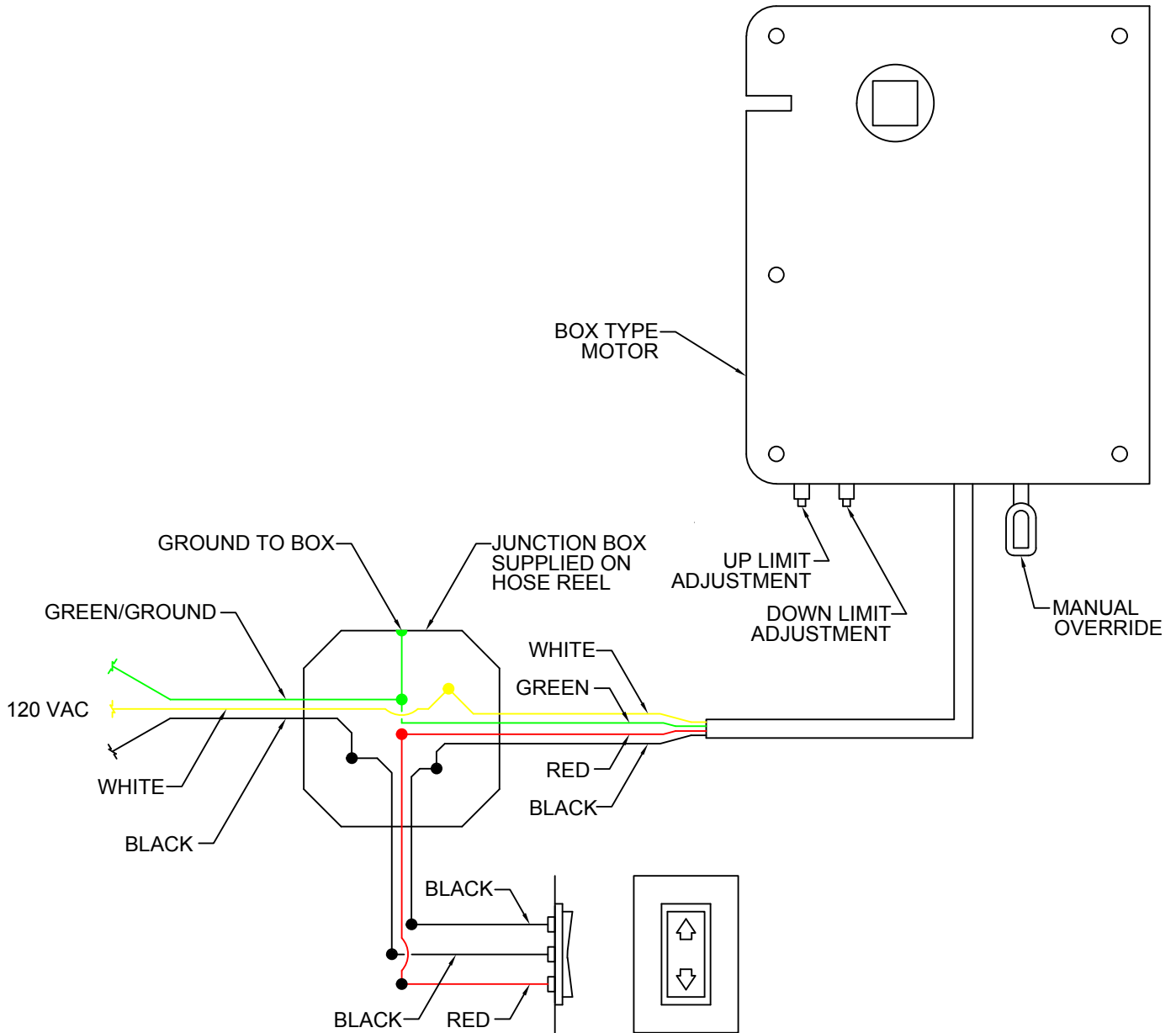

NOTE: The rocker switch may be set-up for a pendulum application. If a pendulum is desired, Monoxivent will supply the rocker switch, cover box, 20' power cord, strain relief fittings, and junction box on the hose reel.

NOTE: The wiring diagram, above, is for 120 Volt. Motors are available in 220 Volt. Please consult factory for wiring diagram.